

SPINNOVATION

THE MAGAZINE FOR SPINNING MILLS

No. 32 10/17



Bräcker

Grat

Novibra



Suessen

IMPRESSUM



Publication Information:

No. 32 – October 2017

SPINNOVATION

Editor in Chief: Serge Entleitner

E-Mail: mail@suessen.com

Published by the 5 Companies

Bräcker

Bräcker AG, Obermattstrasse 65
8330 Pfäffikon-Zürich, Switzerland
www.bracker.ch



Graf + Cie AG, Bildaustrasse 6
8640 Rapperswil, Switzerland
www.graf-companies.com

Novibra

Novibra Boskovice s.r.o., Na Kamenici 2188
68001 Boskovice, Czech Republic
www.novibra.com



SSM Schärer Schweiter Mettler AG
8810 Horgen, Switzerland
www.ssm.ch

Suessen

Spindelfabrik Suessen GmbH
Donzdorfer Strasse 4, D-73079 Süssen
Germany
www.suessen.com

Title registered® at German Patent Office

Copyright © 2017

Spindelfabrik Suessen GmbH

All rights reserved

Reprint of articles with reference permitted

– Voucher copies desired

Front cover: Bräcker ring and traveller in motion

Inside front page: LENA Spindle

Back cover: TwinDisc Bearing



Serge Entleitner
Head Business Group RCO
Editor in Chief SPINNOVATION

Dear Reader,

“SPINNOVATION” is the most widely read customer magazine in the world of spinning and its downstream processes. And this latest edition is ready for you just in time for Shanghaitex 2017, giving Rieter Group companies Bräcker, Graf, Novibra, Suesen and SSM a chance to present their new products and their benefits.

This information is then backed up with customer experiences, otherwise known as “testimonials” in marketing speak. These are important for our business because our products need to prove their worth in daily use by our customers.

Another highlight of this edition is the integration of SSM (Schärer Schweiter Mettler AG).

SSM was taken over 100 % by Rieter in July and integrated into the Business Group Components. In this edition, we introduce the company and its products and there is one piece of news that I can already divulge here: The SSM product portfolio goes well with our existing premium product portfolio, and is a perfect extension to the range of Rieter products available in the textile value chain. My team and I are pleased to have the opportunity to supply our customers with additional, unique products and to acquire new customers.

Let me provide you with an overview of the innovative products that we are going to present in this publication.

Thanks to their long service life and production characteristics, Bräcker travellers excel in every spinning mill around the globe. With the new ONYX traveller, we are expanding the range. At high spindle speeds, the ONYX traveller sets itself apart with its improved lubrication between traveller and ring. This not only extends the service life of the traveller, but also that of the spinning ring. The spindle speed can be increased by up to 1,000 rpm, enabling higher yarn production.

In this Spinnovation, Graf focuses on customer service. Selecting the right clothings and the right combs according to the raw material to be processed is of key importance. Graf provides all-round support that is guaranteed around the clock, with specialists on site and at the company headquarters. This ensures a longer product service life and improved spinning process quality – and that pays off for our customers.

With the CROCOdoff clamping crown, Novibra has developed and launched the only retrofittable system for underwinding-free spinning that can be used on every ring spinning machine. The Pakistani market, which is known for producing with the highest spindle speeds and somewhat coarser yarn counts, proved to be a challenge for the CROCOdoff – but one which this system mastered. Read the interview with our customer Mr. Ghulam Murtaza, General Manager at Indus Dyeing & Manufacturing Limited.

Suessen is introducing a solution to replace pneumatic top arms with flat spring loaded top weighting arms on ring spinning machines. This well established top weighting arm is characterised by low variation in pressure deviations across all spinning positions. In combination with a new cradle and various PINSpacers the yarn quality and spinning stability meet even the most challenging demands that high-end spinning mills make on a top weighting arm. This helps our customers achieve better yarn returns, improves their market position and the reliability of downstream processes.

My Team and I assure you that we will keep our promises. The positive customer testimonials are evidence of this.

I look forward to getting to know you as a customer.

Best regards,

CONTENT

CONTENT	4
TRENDS.....	5
ONYX Travellers –	
An optimized surface functionalization	5
Key components for ring spinning machines, which are able to withstand rough conditions during application, have gained increased attention in recent years.	
Customer support is key	7
Customer service is a priority at Graf's and professional support for our customers is not just an empty phrase but a promise.	
HP-GX 3010^{RPT} Top Weighting Arm	11
Mechanical solution for replacement of pneumatic top weighting arms	
Natural lubrication of spinning rings	16
MILL REPORTS	18
Indus Dyeing & Manufacturing Company Limited	18
Thien Nam, Vietnam	21
Success is the Result of Hard Work and Total Dedication	
The key to success of Indus Group, Pakistan	24
Indus Group started its business in 1955 with one cotton ginning factory and now they are one of the best established textile groups in ginning, yarn spinning and towel businesses with over US\$70 million annual turnover.	
Sintex Industries Ltd. - Yarn Division.....	26
Sintex Industries Ltd is an Indian conglomerate with operations in textiles and plastics with a turn-over exceeding USD 1 Billion.	
Nannu Spinning Mills –	31
Social Responsibility and Success: No contradiction	
Far Eastern Industrial Wuxi, P.R. China	33
It is a branch of the Far Eastern New Century Corporation (FENC) which was founded in 1945 and now is located in Taiwan.	
NEWS	35
SSM – combined power of over 300 years of experience	



ONYX Travellers – An optimized surface functionalization

Key components for ring spinning machines, which are able to withstand rough conditions during application, have gained increased attention in recent years. The wide range of technical requirements for the components comprises reliability, prolongation of lifetime and increment of speed.

Being the world market leader, Bräcker use their extensive understanding of the industry and technical knowledge for permanently optimizing and improving these components.

Since the demand of higher efficiency has introduced a new era for the performance of the components, one should distinguish between two categories of lifetime. The long term component (ring) comprises several years of lifetime whereas the short term component (traveller) may last up to several weeks. Bräcker focuses on both, the improvement of the ring performance as well as the increase of lifetime and speed of the travellers without any sacrifice.

Therefore a thorough understanding of the tribological phenomena that take place during spinning is crucial. This scientific issue requires an in-depth insight on the interaction at the traveller/ring interface and the influencing factors on the wear mechanism

during spinning. It is known that the formation and stability of a lubrication film is essential for the traveller and that it prevents premature failure. However, it is not only the lubrication that enhances lifetime but also the surface properties of the traveller which prevent onset of failure in the early stage of spinning.

In recent years the enormous importance of the wear mechanism taking place in the very early stage of the spinning process gained growing attention. This phenomenon is a key factor for the lifetime of the traveller and thus for the optimization of the surface properties that play a crucial role before the formation of the lubrication film. From several studies investigating this effect, Bräcker gained an in-depth understanding on the wear mechanisms and influencing factors. Based on this background, a new traveller surface treatment, ONYX, with highly improved sliding properties has been developed, Figure 1.



Fig. 1: ONYX – the traveller for the highest demands.

ONYX creates new potential

Figure 2 shows the different stages of service time. The dependency of the coefficient of friction of a conventional and an ONYX traveller are shown. Phase 1 describes the first tribological interaction at the traveller/ring interface which starts with a high coefficient of friction due to lack of lubrication in the very early stages. When the initial lubrication film is formed the friction coefficient passes over to a steady state equilibrium (Phase 2) where continuous formation of

the lubrication reduces further wear of the components.

After passing of a critical time, a drastic increase of the coefficient of friction is observed (Phase 3), accompanied by wear induced failure of the traveller. Owing to the lower coefficient of friction of the ONYX surface finish established by adjusted surface functionalization it is possible to overcome the initial threshold (Phase 1) without wear loss of the traveller in the early stage of spinning.

The optimized start-up in Phase 1 leads to a less impaired surface when entering in Phase 2. As a consequence, the lifetime (RPM, respectively) can be increased significantly and thus the productivity of the spinning machine can be enhanced.

ONYX makes the difference in efficiency

When compared to SAPHIR, this high-tech surface treatment allows an increase by 50 % in lifetime and an increase of up to 1000 spinning RPM, respectively. Besides the technical benefits, a traveller has to fulfil the complex requirements from the field of application. Therefore the suitability of new products to a wide range of yarn counts as well as compact and non-compact yarns is a fundamental requirement.

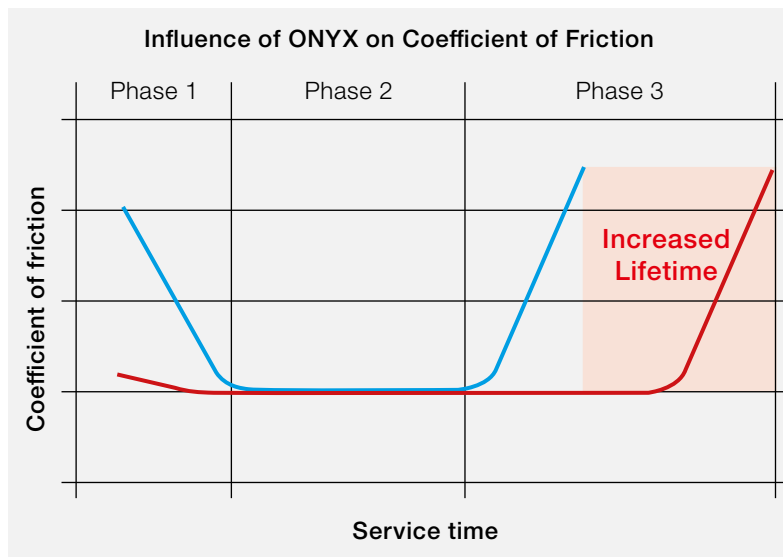

Fig. 2: Influence of ONYX on coefficient of friction — SAPHIR — ONYX

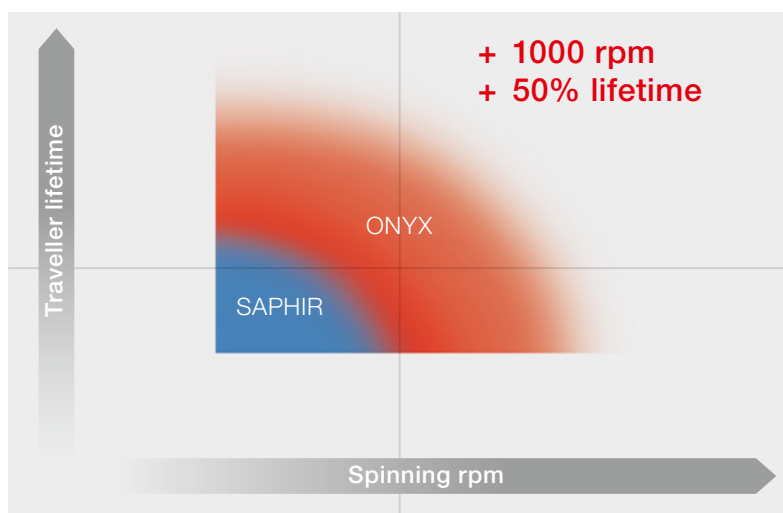

Fig. 3: Tests in various spinning mills in different countries have shown a significant gain in traveller service life with ONYX compared to SAPHIR.

The new product, ONYX, was successfully launched in April 2017, creating new potentials in the ring spinning industry due to facilitated increase of efficiency. The benefits of the ONYX surface treatment gives rise to improved production in the spinning mills at an efficient price-performance ratio.

Customer support is key

Customer service is a priority at Graf's and professional support for our customers is not just an empty phrase but a promise. This Graf fulfils, from the initial evaluation of the clothings to the installation up to the 'end of life' of its products. The esteemed customers can count on proven experts that are at their service on-site as well as in the head office in Rapperswil (CH).

Detailed information on the raw material processed and the intended yarn count are the key parameters in the selection of the correct clothings for the components of a card. The eventual yarn count can be considered quite easily in the specification in this early stage of the spinning process, since it just depends on the fibre length and the carding fineness. The raw material, on the other hand, is far more difficult to handle.

For cotton and/or man-made fibres Graf differentiates between a total of 25 different processes, each with 2 to 3 production rates and for each process defines a number of different clothing combinations for the main cylinder, doffer, licker-in and flats. These specifications are optimized for the more than 200 known types of cards and their characteristics.

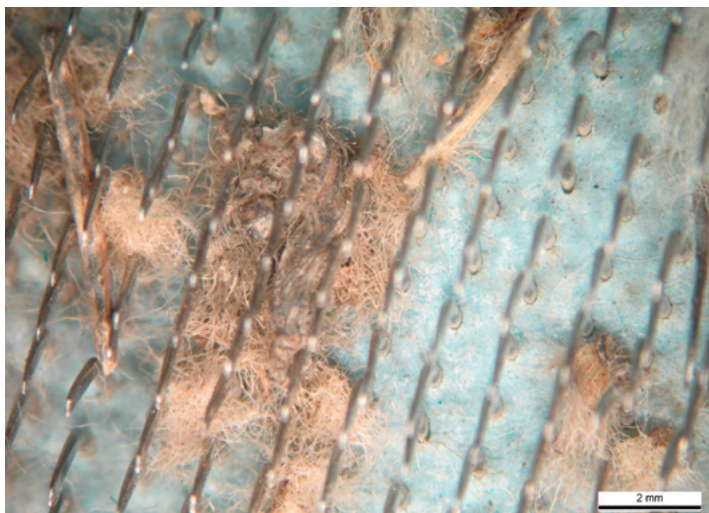

Fig. 1: Excessive contamination of flat clothing with subsequent damage due to wrong settings in the blow room

For rollers with larger diameters, for example, metallic card clothings with a more aggressive working angle are installed and, depending on the operating speed or the throughput respectively, different densities and tooth shapes are chosen.

Not only the wire geometry or the choice of alloy are at the centre of this consideration, but always the interaction of the individual clothings and customer's machinery, too. Graf, for decades, has gained experience and has optimized its clothing combinations, in some cases specifically for individual types of cards and card makers; resulting in the availability of around 1,500 different clothings to perfectly meet all conceivable requirements of the customers.

Some properties of cotton as a natural raw material, e.g. trash content, do have an effect on the selection of the clothings (Fig. 1). The trash content in the cotton can be compensated to a certain degree by the choice of the clothings, e.g. with more sturdy flat clothings. However there are physical limits resulting in the confrontation with a classical problem of optimization. A lower rate of waste extraction in the blow room increases the material yield and economic efficiency – but also the trash content in the subsequent processes.

This causes damages, and the premature wear of the clothings on the card results in lower quality, decreased revenue and an increase in maintenance costs. Graf provides its customers with support in accurately matching the settings in the blow room, mote knives etc. to ensure production in an optimal operating point – economically as well as technically.

Following the selection of the best possible clothing combination, a professional installation and maintenance is decisive for the clothings to perform to their full potential. Graf continuously strives to convey the correct use of its products to its clientele and the quality-assurance laboratory at the head office in Rapperswil provides an indispensable contribution in determining the action required. Most of the defects reported and problems encountered by customers are consequential damage resulting from incorrect handling of material and equipment – which basically is easy to prevent, provided the critical points are known and observed.

Common error patterns are illustrated in the picture spread. Horizontal storage or wrong positioning of coil when mounting damages the tooth points of the clothing and renders it unusable from the start (Figs. 2 and 3). The periodic markings at the wire base are clearly visible, caused by contact with the tooth points.

Quite frequent damage symptoms are shown in Figs. 4 and 5: a crash of the flat clothings with the cylinder. As a result of the increasing production speeds and working widths of the cards, the permissible machinery parameters and tolerances become closer, and as such also the margin for inaccuracies and faults.

While subsequently the cause of the damage is evident, the necessary measures can vary greatly. Further analysis indicates whether the flat clothings were correctly resharpened at the time of service, whether the carding gap was set correctly or whether customer's production process was run incorrectly, so that excessive thermal stress may have led to deformation and thus a contact. Depending on the findings, corrective measures may be taken in the supply chain, the (service) processes or the training of the staff.

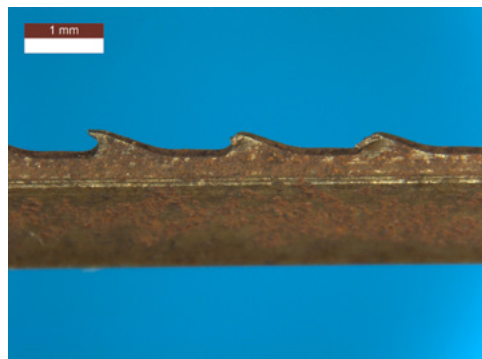

Figs. 2 and 3: Damaged tooth points caused by contact with wire base

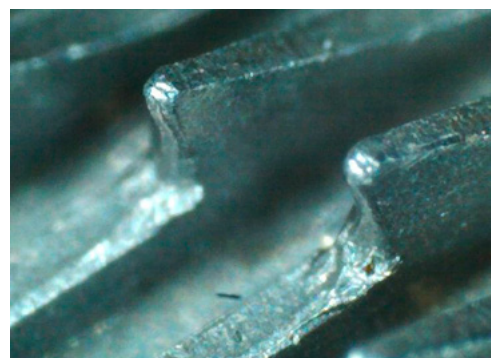

Figs. 4 and 5: Clear signs of crash on the tooth points and the tooth radius

A practical example of troubleshooting highlights the holistic approach of Graf's service concept:

In some cases the cause of the problems is in the operation, but not the clothing itself. (Figs. 6 and 7)

The doffer of a customer's card continued to choke and the machine needed to be stopped and cleaned every second day. Various reclothings with different types of metallic card clothings did not result in any improvement, subsequently Graf was consulted.

Following an in-depth analysis of the situation at site, the Graf specialist noticed that the actual cause was insufficient suction at the location of the card. Since a new suction concept would have meant a considerable investment, a more cost-efficient solution of the problem was searched and finally found. Graf's proposal was to slightly increase the speed of the draft web-belt of the card and adjust the coiler tension accordingly.

As a result of the new parameterization of the card the process runs flawlessly and customer's problem could be solved lastingly.



Fig. 6: Choked doffer at customer's site, requiring cleaning every other day

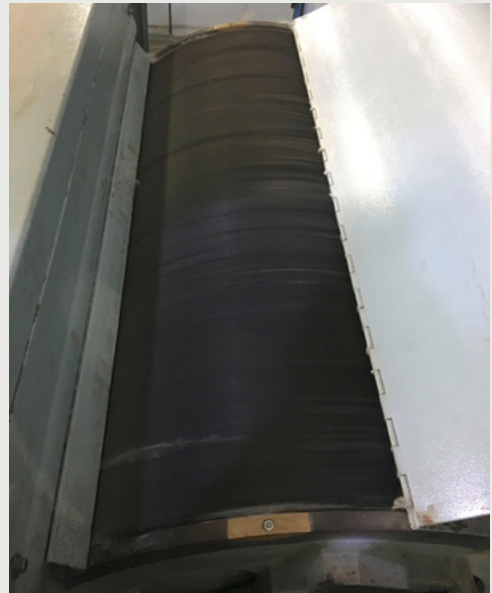

Fig. 7: Doffer following successful troubleshooting and operation of some weeks

Graf + Cie AG maintains 36 workshops worldwide in close co-operation with its local partners (Fig. 8) and supports their customers with regular service work, troubleshooting and optimizing of processes at site.

Furthermore the technical customer consultants and agents are constantly engaged with selecting the best possible clothing combinations for the customers' production processes. In doing so they can count on the full assistance of the engineers and the technical staff from development, quality assurance and production at Graf's, who, on request, realize unusual customers' wishes and work out individual solutions.

Eventually the key to the success of Graf + Cie AG is the success of its customers – this is what Graf works on day for day.



Fig. 8: Graf Workshops, Status at 07.2017



HP-GX 3010^{RPT} Top Weighting Arm

Mechanical solution for replacement of pneumatic top weighting arms



Fig. 1: HP-GX 3010 Top Weighting Arm, here with EliTe[®] Advanced Compact Spinning System

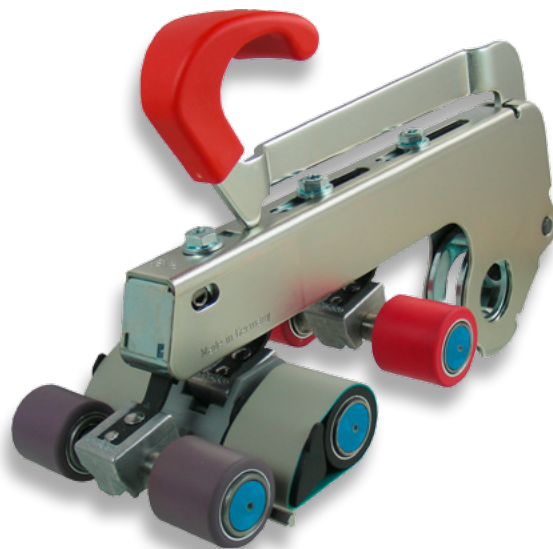

Fig. 2: HP-GX 3010^{RPT} Top Weighting Arm with top roller equipment from original top arm and Active Cradle mit PINSpacer NT

Replace your pneumatic top weighting arm system by the reliable HP-GX 3010^{RPT} Top Weighting Arm and reuse your top roller equipment. The HP-GX 3010^{RPT} meets even the most challenging demands that high-end spinning mills make on a top weighting arm.

Many spinning mills suffer from the insufficient performance of their pneumatic top arm installations. They want to replace their pneumatic top arm installations for these reasons:

- Highly energy consuming pressure supply in case of old pneumatic hose
- High maintenance costs due to aging of the pneumatic hose and other parts

Uncertainty about the real weighting load: due to the pressure drop along the machine the pressure displayed at the headstock does not represent the individual pressure.

Pneumatic top arm pressure variation

Different solutions are offered on the market to transform a machine equipped with pneumatically loaded top arms to mechanical load. For example, the pneumatic hose in the hexagon tube is replaced by a set of springs.

Examinations have shown, however, that such systems are not able to provide a homogeneous load. On the one hand this is due to the hexagon tube, which is too soft to withstand the torque and the deflection resulting from the load force taking effect, so that the tube is elastically deformed.

As a result, the weighting pressure in the roller stand section varies a lot. Immediately adjacent to the right and left side of the roller stands the pressure is quite acceptable despite the torsion and deflection of the hexagon tube under the load, while at the two middle top arms it is too low.

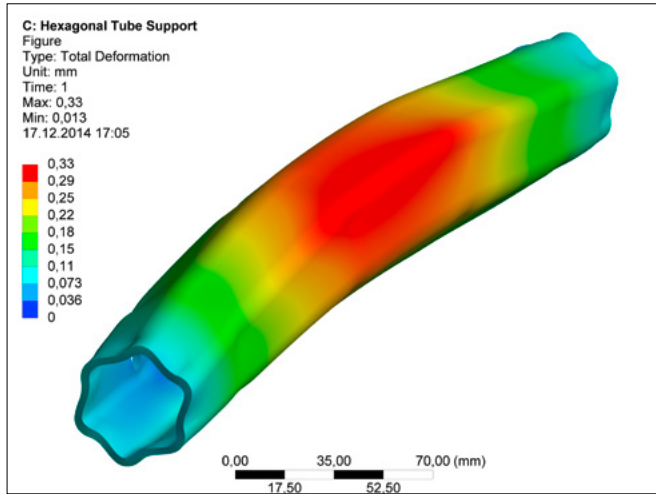

Fig. 3

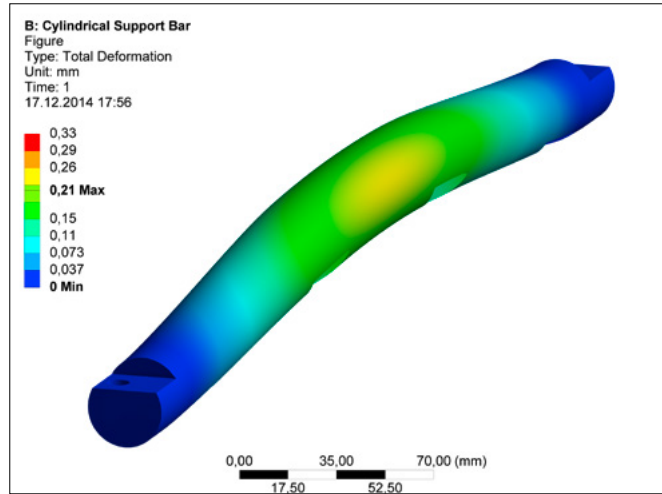

Fig. 4

Fig. 3 shows a considerable deflection over almost the whole length of the support bar tube, while the strong support bar of the HP-GX 3010^{RPT} design (Fig. 4) only shows a short area of deflection.

Due to the design of the solutions described, the distance between front bottom roller and support bar tube is by about 30 mm larger than with the RPT solution. So in case of an identical weighting pressure on the top rollers, the moment acting on the hexagon tube is almost 15 % higher, resulting in increased torsion and consequently even more pressure variation.

This disadvantage is common for competitive systems that are still fixed at the hexagon tube. Based on the well-known physical lever principle, the lack of rigidity of the hexagon tube combined with the about 15 % higher torque inevitably leads to increased deflection under the same load and increased distance, i.e. variation of the lever or, in our case, the top arm.

From this point of view alone, a system of mechanical load maintaining the original hexagon tube is not a good solution.

We measured the top weighting arm load on two ring spinning machines (Fig. 5). The load was set at 22 kp. We have found a comparable situation for many years and in many different spinning mills. Any variation (higher and lower) influences the yarn quality and represents the yarn quality variation between the individual spinning positions.

Fig. 5

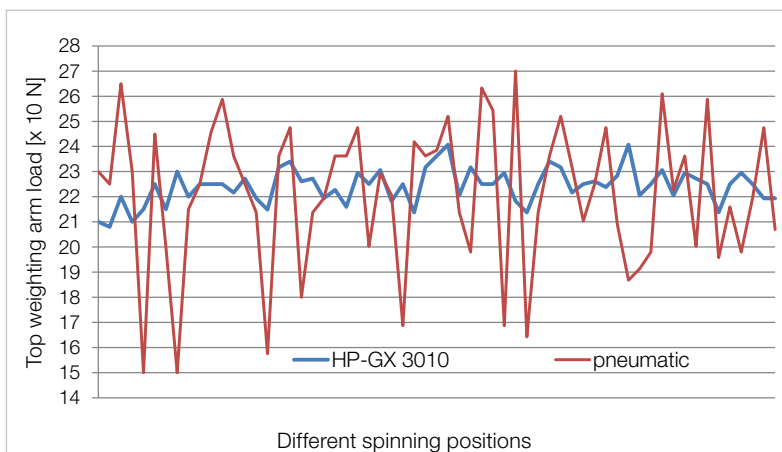

Customer benefits by replacement of pneumatic top arm with SUESSEN HP-GX 3010^{RPT} Top Weighting Arm

- Reduced energy consumption
- Reduced maintenance effort/costs – less consumables
- Improved yarn quality – sustained constant yarn quality from spinning position to spinning position
- Lower ends-down rate

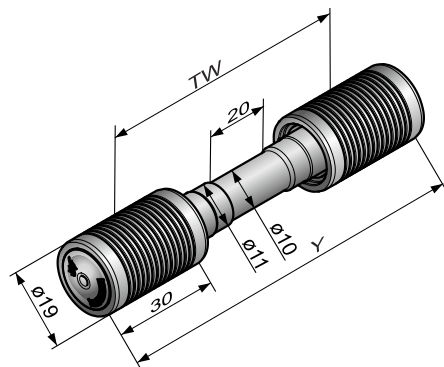

Fig. 6

In Table 1 on page 11 you can find exemplary comparisons of different mills.

Scope of Delivery

The basic scope of supply comprises the HP-GX 3010^{RPT} Top Weighting Arm with 3 top weighting units and Suessen Active Cradle. The cradle is applicable for top rollers with Ø 25 mm and top roller aprons with Ø 38.1 mm as well as top rollers with Ø 27 mm and top roller aprons with Ø 39.2 mm.

Generally you can reuse your set of top rollers (if they are in good condition) as the retainers of our weighting units are compatible with the saddle of the respective rollers (see Fig. 6).

Optionally you may order from Suessen the necessary support bar with connecting parts to the roller stands, PINSpacer NT and clearer roller support.

The Suessen HP-GX 3010^{RPT} Top Weighting Arm is available for conventional ring spinning and for Suessen EliTe[®] Compact Spinning.

Distinctive Features

- Optimum yarn quality
- High consistency of all yarn parameters
- Sustained yarn quality
- Minimal variation between spinning positions
- Maximum drafts
- Easiest operation
- No restrictions in regard to raw material
- Heavy-duty plate springs



Fig. 7

Principle of frictionless load

The important feature of the HP-GX 3010 family is that the top rollers are loaded directly by heavy-duty plate springs without clearance or friction (Fig. 7). Furthermore, the plate spring is supported free from play in the top weighting arm body. At the same time, the plate spring serves as a guiding element and prevents an oblique position of the top rollers.

Heavy-duty plate spring

The heavy-duty plate spring, hardened and protected with a special coating, serves simultaneously as a guiding element. As a result, fewer movable components are required and – different to other designs such as pneumatic solutions – a frictionless control of the top rollers is provided. The computer-optimized leaf spring design prevents an oblique position of the top rollers (Fig. 8).

Fig. 8

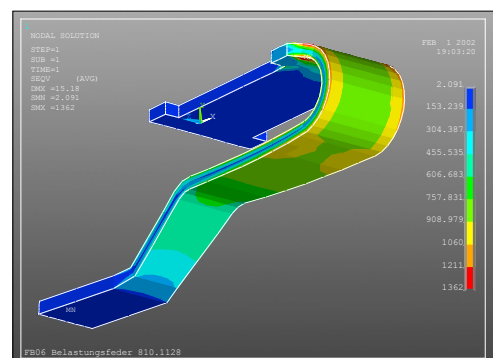

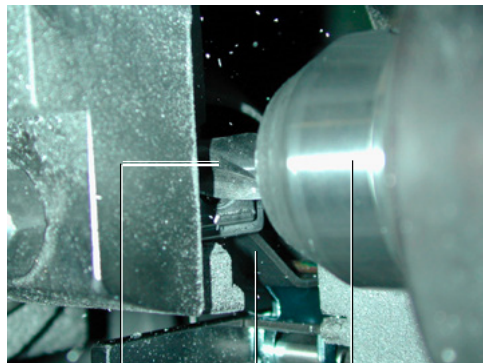

Fig. 9: helical milling cutter preloaded weighting unit milling head

In addition, the mechanical treatment of the wide top roller supports will guarantee the precise parallelism of the top and bottom roller axles. (Fig. 9)

Conventional weighting units loaded by a coil spring or pneumatic units tend to evade laterally, so that top rollers take an oblique position. The reason is that the ends of flat coils are never 100 % parallel and bow laterally when loaded in the centre.

Pneumatically loaded systems usually are equipped with loading elements subject to friction. Due to the hysteresis effect of such systems, the load varies to a more or less great extent. The advantage of central load relief is compensated by a restricted reliability.

In today's spinning mills being in operation 24 hours a day and 12 months a year, central load relief is no longer a significant advantage.

Setting of front top roller position

The position of the front top roller on the HP-GX is set in the Suessen factory. The high-end Suessen HP-GX 3010 top weighting arm family enables you to adjust the front top roller position to meet your precise technological requirements.

Active Cradle

The Suessen Active Cradle (Fig. 10) provides highest stability and unique fibre control

PINSpacer NT

The innovative PINSpacer NT (New Technology) is the result of intensive studies: the design solves the problem of separating the two setting parameters of "apron nip" and "pin position".

The PINSpacer NT makes allowance for the whole potential of adjustment: after preselecting the apron nip it is possible to adjust the immersion depth of the pin by 5 different attachments to the demands of the spinning mill.

Owing to the oval cross-section of the PIN NT, the fibres are securely prevented from running over the pin. Due to the inclination of the pin, fibres are reliably guided to the pin's underside.

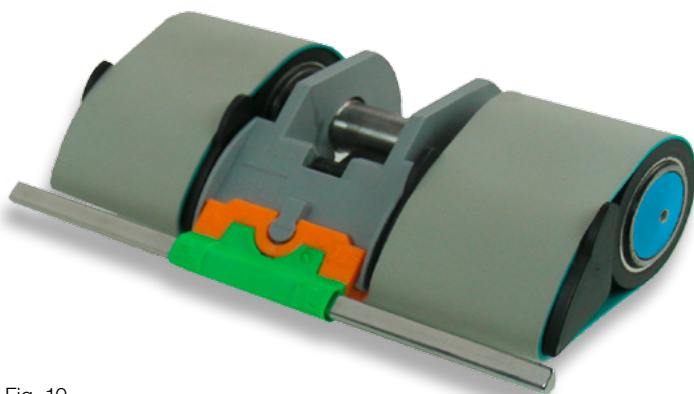

Fig. 10

Customer	Mill A			Mill B			Mill C			Mill D		
Count (Ne)	26/1 combed compact - knitting		% improvement by HP-GX 3010	40/1 combed compact - weaving		% improvement by HP-GX 3010	60/1 combed compact - weaving		% improvement by HP-GX 3010	100/1 combed compact - weaving		% improvement by HP-GX 3010
Top Arm	pneumatic	HP-GX 3010		pneumatic	HP-GX 3010		pneumatic	HP-GX 3010		pneumatic	HP-GX 3010	
Irregularity												
U%	9.29	8.73	6.03	9.48	9.17	3.27	10.47	9.8	6.40	12.2	10.8	11.48
Imperfections - normal												
Thin places (-50%)	0.8	0		2	0		1	1.7		78	13	
Thick places (+50%)	17	7		20	14		44	23		68	18	
Neps (+200%)	20	13		70	65		104	85		46	28	
Total	37.8	20	47.09	92	79	14.13	149	110	26.17	192	59	69.27
Imperfections - High Sensitivity												
Thin places (-30%)	750	580		808	713		1442	1141		3201	1989	
Thick places (+35%)	206	86		178	134		382	218		628	274	
Neps (+140%)	89	56		263	246		400	339		327	207	
Total	1045	722	30.91	1249	1093	12.49	2224	1699	23.61	4156	2470	40.57
Fuzziness Properties												
H	5.43	5.3	2.39	3.3	3.28	0.61	2.2	2.2	0.00	2	2	0.00
Sh	1.13	1.09	3.54	1.09	0.9	17.43	0.38	0.37	2.63	0.41	0.4	2.44
Tensile properties												
RKm	15.19	16.66	9.68	20.75	21.45	3.37	22.83	23.9	4.69	28	30.4	8.57
RKm CV%	8.6	7.5	12.79	9.6	8.5	11.46	9.44	7.1	24.79	12.1	10.6	12.40
Elongation E%	4.6	4.9	6.52	4.6	4.9	6.52	4.28	4.6	7.48	2.9	3.1	6.90
Elongation CV%	10.5	9.6	8.57	9.6	8.6	10.42	13.4	10.3	23.13	16.1	13.4	16.77

Table 1: Comparison of pneumatic top arm vs. Suessen HP-GX 3010 Top Weighting Arm

Natural lubrication of spinning rings

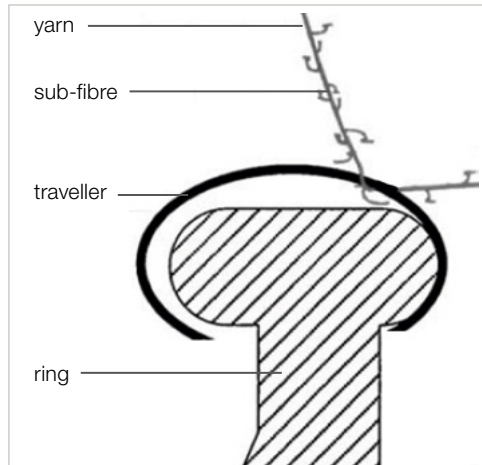

Fig. 1: Spinning ring-traveller contact (Fervel et al., Wear 254, 2003)

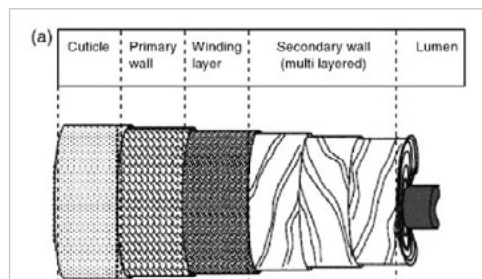

Fig. 2: Schematic representation of a mature cotton fibre (Kozlowski, Handbook of natural fibres, 2012)



Fig. 3: Tribometer at IMPE in Winterthur

In ring spinning of cotton, the twisting motion of the yarn is achieved by the high-speed revolution of a traveller on a ring. During rotation of the traveller, non-aligned sub-fibres are sheared-off from the yarn and trapped in the ring-traveller contact (Fig. 1).

Since the 1960s, it is well accepted in the spinning industry that a natural lubrication mechanism is active. This natural lubrication prevents severe wear of the spinning ring and the traveller made of steels that occurs under dry friction conditions. Up to now, the formation mechanism and the composition of the lubrication film are not completely understood. Therefore, tribological studies were made at the Institute of Materials and Process Engineering in Winterthur, Switzerland, in cooperation with Bräcker AG.

Composition of cotton fibres

A mature cotton fibre consists of four layers that enclose the lumen: the multi-layered secondary wall (crystalline cellulose), the winding layer (transition between secondary and primary wall), the primary wall (amorphous cellulose, pectins, hemicelluloses, proteins and ions) and the cuticle (waxes). A schematic representation of a cotton fibre showing its various layers is given in Fig. 2.

Experimental setup for tribological tests

In order to simulate the sliding movement of the ring and the traveller a commercial oscillating tribometer was used (Fig. 3). The tribometer controls the relevant parameters such as normal force, movement and temperature in closed-loop and simultaneously measures wear and friction force. Normal and friction force allow the real time calculation of the coefficient of friction. The tested tribological system consisted of body and counter body made of steels in combination with a cotton roving Ne 1.28.



Fig. 4: Coefficient of friction with and without cotton fibres



Fig. 5: Contact surface of ring material after tribological testing

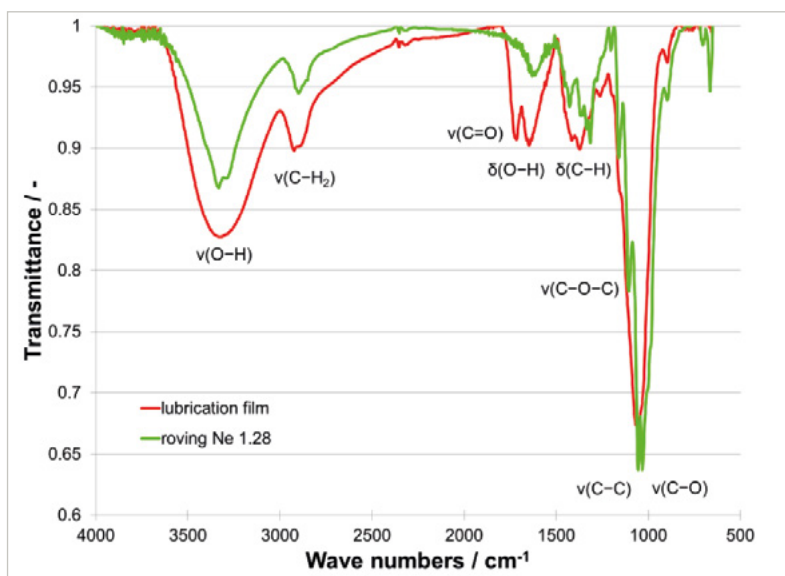

Fig. 6: FTIR spectra of the lubrication film and cotton fibres

Analysis of the natural lubrication

The coefficient of friction in the presence of the cotton fibres was significantly lower than in absence of the fibres (Fig. 4). In one of the tests, the cotton fibres were removed after 7 seconds and the coefficient of friction instantaneously reached the value of the condition without fibres. This result clearly demonstrates the effectiveness of the lubrication film.

The surfaces of the tribological contact showed traces of a lubrication film that is the result of the complex interaction between the constituents of the cotton fibre and the tribological loading (Fig. 5). It demonstrates that cotton fibres are “crushed”, spread and deposited on the surface by the traveller due to very high contact pressures.

In order to analyse the composition of the lubrication film in detail infrared spectroscopy (ATR-FTIR) was performed (Fig. 6). A comparison between the spectra of the used roving Ne 1.28 and the lubrication film certainly shows that the lubrication film is formed from cotton constituents. However, more interesting is the “crushing” of cotton fibres, which majorly means a breaking process of the hydrogen bonds of the crystalline cellulose and minor a release of pectins, proteins and waxes. The spectrum clearly demonstrates that H₂O molecules (e.g. the O-H band at 1645 cm⁻¹ in Fig. 6) are adsorbed by occupying free bonding positions at the loose cellulose chains forming the lubrication film.

Outlook

These results originate from Bräcker's close collaboration with the Institute of Materials and Process Engineering at Zurich University of Applied Sciences. They form part of Bräcker's continued research activities regarding the underlying principles of the spinning process itself, and will be used to continuously optimize our products to the highest performance level.



Indus Dyeing & Manufacturing Company Limited



Mr. Ghulam Murtaza, General Manager



Contact:

Indus Group of Companies
#508, Fifth Floor
Beaumont Plaza
Beaumont Road
Civil Lines Qtrs
Karachi-75530
Pakistan
Phone: +92 21 111 404 404
Mail: info@indus-group.com
Website: <http://indus-group.com>

History and product portfolio of Indus Dyeing

Indus Dyeing & Manufacturing Company Limited was incorporated in Pakistan on July 23 in 1957. Registered office of the company is situated in Karachi and the company is currently listed on the Pakistan Stock Exchange Limited. The principal activity of the company is manufacturing and sale of yarn. The manufacturing facilities of the company are located in Karachi, Hyderabad and Muzaffargarh. The company is also operating two ginning units including one on leasing agreements in District Lodhran.

Indus Dyeing Group also participates on social activities for their labours. The Indus Dyeing School for children was founded in 2014 with the aim of making excellent education accessible to the children of workers at Indus Dyeing Mills, Hyderabad. Within three years, the school now stands strong with a strength of 170 students and 12 teachers.

Production portfolio

One of the main production processes of Indus group forms yarn spinning which is company's core business. Indus Dyeing makes many kinds of ring-spun yarns, some of which are regular carded and combed yarns which are made in large quantities for both knitting and weaving.

Indus Group markets its yarn under many different brand names. These include the top brands of the Chinese market like Derby, Rugby, Indus, Jet, Baseball and Royal Top. Indus group is a pioneer in the Siro market and its brands are a byword for quality and reliability. Indus was one of the first Pakistani companies to start exporting Siro yarns into the Chinese market and is now the largest supplier of Siro Yarns to China with an export of more than 4,500 tons a month.

Melange yarns are produced under the Group's Oyster brand, known as one of the top melange brands in Pakistan for more

than a decade of performance in quality exports serving the American, Italian and Korean markets.

The Group has also the experience of providing untraditional yarns as a Zero twist – these are mainly used as pile yarns in terry towels. Due to their extremely low twist, towels made with this yarn have higher moisture absorption, soft feel and more radiant colours.

In the quest to improve quality and competitiveness, the company has installed as a first one in Pakistan spindles with CROCOdoff clamping crown on RX 240 in 2016 and we bring herewith an interview with General Manager Mr. Ghulam Murtaza who likes to share his experience with this new product.

Interview with General Manager Mr. Ghulam Murtaza.

While visiting customers all over Pakistan, I have learnt that Indus Dyeing is a very well-known company with the highest trade mark of quality. How have you managed to gain such a reputation?

Hard working, discipline and team work help me to improve the productivity with efficiency. Investment on new tech-

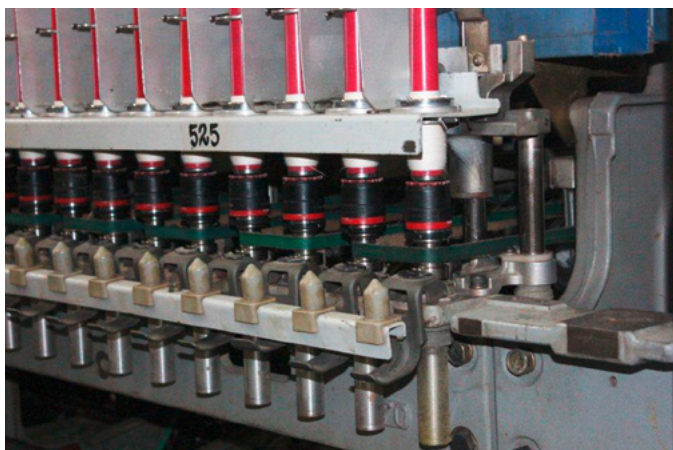

CROCOdoff clamping crown on RX 240

nology helps me to improve production and reduce overhead costs (labour and energy saving). At Indus Dyeing, the passion for quality underlies every endeavour. From acquiring the best of technology, to bringing together rare talent, the Indus Dyeing ensures that its products always conform to the highest possible quality standards. Each division is equipped with modern and sophisticated products, making it possible for Indus Dyeing to make inroads in quality conscious market in Pakistan and also throughout the world.

Indus Dyeing is running new generation of clamping crowns – CROCOdoff – the first ones in Pakistan. Mr. Murtaza, how did you learn about CROCOdoff product?

I am always interested in new inventions and innovations. Actually CROCOdoff product attracted me at ITMA Milano 2015, where Novibra was demonstrating spindles with CROCOdoff at their showcase booth. And after my discussion with Novibra representatives and their agency in Pakistan M/s. Associated Textile Consultants Ltd., I came to the conclusion that this product will definitely deliver my expectations.

What specifically attracted you about CROCOdoff specification?

At the top would be especially the reduction of the yarn breakage and avoiding the fluff in department which results in well controlled spinning conditions, absence of uncontrolled yarn-end flying, saving of labour staff since there is no need for frequent cleaning of the cutting crown. And finally there is the advantage of easy fixation on the spindle and its replacement.

For how long are you running spindles with CROCOdoff?

We have been using this CROCOdoff system for about 11 months. Since

then, we have been fully satisfied with its performance. Progress in quality and smooth running can be observed significantly at the spot. Cooperation with Novibra brings us latest spinning technology for our purposes which gives us also the opportunity to work with the best components available on the market.

What is the quality improvements achieved since your mill is using CROCOdoff?

It has helped us to reduce short and long cuts in Autocone. Brought reduction in splices, another reduction of suction mouths working resulted in less hard-waste since there is no uncontrolled yarn ends flying in the ring department. Generally, higher productions, excellent product quality, reliability of end product and consistent performance results in notable features bringing in satisfied customers for the group.

Thanks to CROCOdoff we are able to reduce the ends-down rate after doffing, flying fibres are reduced due to less underwinding and initial breakage of ring frame with CROCOdoff is significantly better compared to normal spindles. Furthermore, there is no need to stop and clean the ring frame daily

anymore. Previously, there was a need to clean the spindles once a week with normal spindles having the old cutting crown. From a technical point of view, CROCOdoff gives us what we need. Just trouble-free performance as it should be.

Do you consider investment into more spindles with CROCOdoff?

Yes, we'll install more CROCOdoff as a replacement of present spindles. We are convinced that the usage of CROCOdoff will contribute to a great extent to the high brand value of Indus Group products in the contemporary textile market.

Would you recommend CROCOdoff product to other spinners?

Yes, we recommend to other spinners to install CROCOdoff and enjoy the improved spinning conditions. I can assure other spinner that they will see very fast the benefits of CROCOdoff. My only advice is always to use premium products for your spinning machines. Do not compromise on low quality and low value investment.

Thank you for your time and chance for sharing your experience with CROCOdoff product.



General Manager Mr. Ghulam Murtaza at the machine with CROCOdoff



Peter Stahlecker
Managing Director

Thien Nam, Vietnam

Success is the Result of Hard Work and
Total Dedication



Contact:

THIEN NAM JSC
Binh An Textile and Garment Industrial Park
Di An Dist, Binh Duong Province
Vietnam
Phone: + 84 650 3774 346
Fax: +84 650 3774 345
E-Mail Sales: sales@thiennamspinning.com
Website: www.thiennamspinning.com

Vietnam is probably the most dynamic – and the most beautiful country I have had the privilege to visit frequently.

Even among the many successful companies, Thien Nam seems to stand out from the crowd!

It was founded in the year 2000 by Mr. Tran Dang Tuong – ‘Mr. Chuc’ as he is known by everybody in the industry. Initially, they traded in raw materials and chemicals for the textile industry, but Mr. Chuc did not stop here! His goal was to build the best spinning mill in Vietnam.

In the short span from 2000 to 2015, he built five factories with totally over 170,000 spindles, where over 2,600 tons per month are produced by 1,700 dedicated employees.

I met Mr. Chuc for the first time in September 2013. He wanted his latest unit, Thien Nam 5, to be totally compact, the first such unit in Vietnam. After tough, but very fair negotiation, we concluded EliTe® for 26 x 1,200 RX 300G.



Entrance to factory Thien Nam



Mr. Chuc, Chairman

After we concluded, he left the details of the exact layout to his very capable ‘second-in-command’, Mr. Du. This seems characteristic of Mr. Chuc: He empowers people. He sets the direction, but allows his very capable staff to fill in the details.

Within a year or so, I do not recall precisely, Thien Nam 5 was completed. Today, it may be the cleanest spinning mill you will ever see.

Installation of the equipment, including our SUESSEN EliTe®CompactSet was uneventful. It was well organized by Mr. Vo, the factory manager. There was not a single complaint from our erection engineers – and this is no surprise. Sooner than most, Thien Nam realized that the most important assets of a company are not its buildings or its machinery, it is its employees! It takes excellent care of its employees – and it gets quality work in return.

Today at Thien Nam 5, highest quality EliTe®Compact yarns are produced in the range of Ne 32 to Ne 100. They enjoy a very good reputation as some of the best yarns available in the market.

“Stillstand ist Rückschritt”, as the German saying goes, meaning if you stop moving ahead you will fall behind. Mr. Chuc may not speak German, but he knows this very well.

He is engaged in an integrated business park in the north of Vietnam, and plans to expand his spinning, too.

Everybody at Suessen is proud to be associated with the leading spinning mill in Vietnam and with its dynamic team!

Quality Specification of Compact Yarn 2017

Ne	Yarn count			Strength on UTJ4			Twist		Unevenness					
	Ne	Δ%	Cv%	P	Cv%	ε%	T/m	Cv%	U%	Cvm%	Thin -50%	Thick +50%	Neps +200%	H
CMP 30	29.94	-0.20	0.86	402	7.09	3.93	813	2.22	8.63	10.86	0.0	3.6	11.9	4.52
CMP 40	39.93	-0.19	0.92	291	7.54	3.78	941	2.07	9.04	11.37	0.1	4.1	15.6	3.97
CMP 50	49.89	-0.22	0.88	236	8.44	3.44	1049	2.19	9.38	11.80	0.5	6.2	25.4	3.71



Mr. Vo, Technical Manager



Mr. Du, Deputy General Director





Farrukh Sharif
MAKVIZ (SSM agent) Pakistan



The key to success of Indus Group, Pakistan

Indus Group started its business in 1955 with one cotton ginning factory and now they are one of the best established textile groups in ginning, yarn spinning and towel businesses with over US\$70 million annual turnover.



Contact:
Indus Group of Companies
#508, Fifth Floor
Beaumont Plaza
Beaumont Road
Civil Lines Qtrs
Karachi-75530
Pakistan
Phone: +92 21 111 404 404
Mail: info@indus-group.com
Website: http://indus-group.com

The spinning operation comprises six spinning mills having 225,000 spindles. A wide variety of yarns are produced in these mills. The spinning mills annually produce approx. 42'000 tons of yarn. In their twisting set up they have 100 TFO machines with a daily production of approx. 66'543 kg. Main count range is Ne 6/2 to 80/2. So far, Indus Group is working with around 600 spindles of SSM assembly winding machines: CW1-D, TW2-D and the latest TWX-D

To find out what impact the SSM machines had on their success, MAKVIZ (SSM agent) have interviewed Mian Shahwaiz Ahmed (one of the owners):

What made you believe that SSM AG was the best for achieving your desired result?

In 2005 we bought the first machine CW1-D assembly winder from SSM AG. Since it is a drum winder we didn't get many extra benefits comparing to other options available in the market, however we found the best after sales service and support from SSM. Later on we bought some Japanese and Indian assembly winders which were not as good as the SSM drum winder machines.

In 2014 MAKVIZ came up with the new idea of knot-free packages on same size TFO pot. We bought the first TW2-D precision assembly winder from SSM and surprisingly with the help of the precision winder we got knot free package which helped us to improve the efficiency of our TFO machines and eliminated our major complaint of twist variation due to knots/splices.

Having this experience we bought seven SSM precision assembly winders (TW2-D / TWX-D) within our group up till now.



Mr. Shahwaiz Ahmed (director / owner)

How did you find the machine/service of SSM and are you happy with the completed job?

With no second thought, SSM manufactures the most eligible machine to perform the desired job and we enjoy the best after sales services from SSM compared to any other supplier in the world.

Would you extend your production with SSM machines and recommend them to a friend?

We are in process to replace our old winders and SSM' precision winders are our first and only choice, since we are proud to have the SSM brand in

our production facility. We are already recommending SSM precision winders to other textile companies.

What are the two most significant improvements that have resulted from work with SSM AG?

We are able to achieve approximately 25-30% more weight on the same package dimensions, with the help of SSM precision winders, compared to random wound package. We are running SSM's new model TWX-D at highest speed without any yarn breaks, due to proper tension control on all spindles, which helps to gain higher efficiency on the TFO process.



SSM TWX-D at Indus Group with Mr. Iqbal and Mr. Sharif

Mission statement of Indus group

We aim to provide superior products, financial security, high performance and quality services that fully meet the needs of our customers and maintain the financial strength of our company. We invite our valued Clients to come and see us how beautifully we are doing all this.



Sintex Industries Ltd. - Yarn Division

Sintex Industries Ltd is an Indian conglomerate with operations in textiles and plastics with a turn-over exceeding USD 1 Billion.



Contact:

Sintex Industries - Yarn Division
Lunsapur, Gujarat, India
Phone: +91 79 27400500
E-mail: yarn@sintex.co.in
Website: www.sintex.in



Fig 1: From right to left:

Mr. Bharat Bhushan Sharma, CEO, Sintex Industries Ltd, Yarn Division; A. G. Desai, CEO, Noveltext; V.M.K Sundaram, Head of Marketing and Sales, RCO India

The Gujarat based, Kalol headquartered company has 17 manufacturing plants in India and 18 abroad, with subsidiaries in 11 countries spread across 4 continents. The group began its operations as Bharat Vijay Mills in 1931, popularly known as BVM and was renamed as Sintex in 1995.

Capacity

Under the dynamic leadership of Mr. Amit D Patel, Group Managing Director, Sintex envisaged on a journey of installing one of the most modern textile complex right amidst the cotton growing area of Saurashtra region of Gujarat state in Western India. The strategic location of the unit in Rajula complementing itself with rich cotton growing area to begin with and the proximity of Pipavav port to export the finished goods, is a testimony to the vision of Mr. Amit D Patel.

Product Details

Sintex Industries Ltd.'s green field project for high quality "No-Touch" yarn with 1 million spindle capacity in Rajula was conceptualized in 2013 with state of the art machinery. The civil work started in 2014 and as of July 2017 they already have 400,000 spindles producing high quality compact yarn. In another two months' time, an additional 200,000 spindles will be commencing production, as the erection work is racing ahead with time in the project site.

Growth plans

Sintex is marching towards their committed 1 Mio spindles of "No-Touch yarn" in breath-taking speed, as one can see from the 600'000 spindles of green field project becoming fully operational within three years' time. The installation of balance spinning capacity (approx. 400,000 spindles) will see investment in specialized applications like Mélange yarn, Dyed yarn and Linen Yarn. This product mix of exotic yarns is aimed for niche product segment, which will add further value to Sintex's operations, apart from the current production of high quality compact and classic ring yarn.

Excerpts from the interview of Mr. B.B. Sharma, CEO of Sintex Industries' Yarn division.

*Question of Mr. V.M.K. Sundaram:
Since when did you know and start using Bräcker Products?*

Answer of Mr. B.B. Sharma:
Bräcker is a well-known brand all over the textile industry. I am working in the textile industry for almost 40 years and have known about Bräcker products since then. Though I was acquainted with Bräcker products from 1985, due to import restrictions it was not easy to procure and use the same. I started using Bräcker travellers regularly from 1992, after the economic reforms made imports possible.

I have been using Bräcker products in the past, during my tenure with companies like Arvind, Morarjee Textiles and Welspun.

In Sintex, apart from TITAN rings and Bräcker travellers, we have become user of BERKOL products also – cots

in our preparatory and the rollshop equipment including fully automatic cot grinding machine supergrinder with integrated Berkoliser – SGLMB.

Question: What is your experience of using Bräcker products – rings, travellers, rollshop equipment and grinding machine?

Answer: During the decades of 1980, when “increase in productivity” became the watch word of industry, I started using Bräcker travellers. Our experience was good as the product satisfied, and to certain extent also exceeded our expectations. From then, our association continued.

When TITAN rings were introduced in the market, I started using the same in combination with the Bräcker travellers and could achieve high productivity with consistent quality. The longer life of the components helped in reduced machine stoppages, further contributing to productivity. Though the initial investment is higher in Bräcker products, due to the above factors, we could

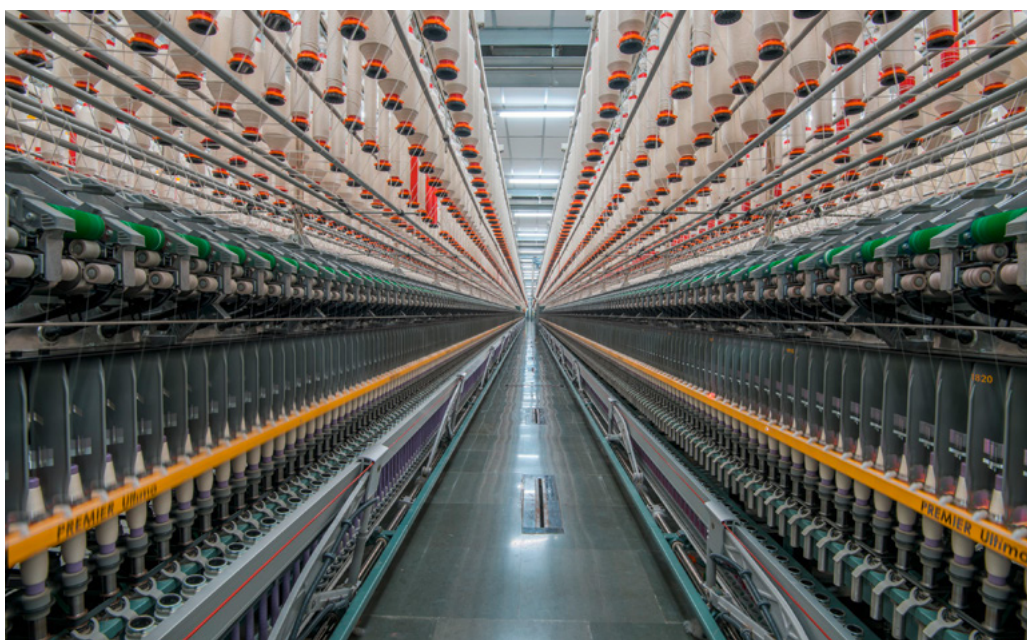

Fig. 2: A glance in a spinning plant of Sintex Industries Ltd

rationalize the costs, which helped in reducing the operating cost.

Currently in Sintex, I decided to go for BERKOL roll shop equipment and fully automatic grinding machines, four of them, as these are now backed with Bräcker service and quality.

Question: Sintex maintains high standard of technology for not only production machines but also maintenance equipment. Why is it so important?

Answer: For me it is absolutely important to have world class service equipment, as they will help me to maintain my production machines in prime condition. Over a period of time, the role of service machines becomes very vital in the up keep of production machines, which has to deliver high productivity and consistent quality with minimal stoppages. A new machine can remain so only for few initial years. Only the right maintenance practice and high quality maintenance equipment will enable us to maintain them suitable for high production continuously.

Question: What are the main criteria you consider, when you evaluate an automatic grinding machine and from when did you start using BERKOL supergrinder?

Answer: As mentioned before, I have a strong conviction that service equipment are more important than the main production machines. Rubber cots in spinning are one of the critical components which need to be periodically ground to maintain the yarn quality. With compact yarn application the frequency of grinding is also more and the accuracy levels of diameter, roundness, eccentricity and surface Ra value play a very important role in determining the working performance and yarn quality.

As per our MD's concept of "No-Touch" yarn, we were automating our plant to the maximum extent and BERKOL supergrinder with integrated Berkolising module for UV treatment fitted in our requirement. Though the initial investment is very high compared to locally produced machines, we decided to invest in BERKOL supergrinders as



Fig. 3: A part of the Sintex roll shop with BERKOL supergrinder

the resultant yarn quality and spinning department performance outweighed the costs in long run. BERKOL's long experience in delivering automatic cot grinding machines to leading mills all over the world was also a factor.

Question: You have big plans to produce Mélangé yarns. There is a traditional thinking that Mélangé yarns do not have requirement of high quality components, say, cots. What is your opinion on the same?

Answer: This is an absolutely unfounded concept, which I do not subscribe to. Since we are using dyed fibres, depending on the blend ratio, we have to reduce the speed sometimes. But in certain blend ratio for Mélangé, we can run the machines at regular production speed, which sets good quality components such as rings, ring travellers and cots, as a precondition.

Today, Mélangé yarn is required in such high quality that we are planning to have compact Mélangé yarns in our product portfolio.

The effect on fabrics produced with Mélangé yarn should be due to the characteristics of fibre blends, colours and certainly cannot be due to yarn faults like unevenness. So in my opinion Mélangé is a more demanding application which requires high quality cots and good grinding machines to maintain the same.

Question: What is your suggestion to Bräcker on product development?

Answer: Bräcker products have always been the benchmark in their respective segments, specifically TITAN rings and ring travellers. I have seen Bräcker continuously introducing new shapes, finishes in travellers according to specific applications.

In case of BERKOL cots, their performance in preparatory segment, especially in draw frames and combers is very good. For the speed frames and ring frames, Bräcker has to develop cots which are affordable.

On the grinding machine, Bräcker should focus on increasing the output to double from the current model. I can understand the conservative approach of BERKOL to allow sufficient contact time to grind the cots for consistent results, but sure you can find ways to increase the output of your machines, which will make the Supergrinder more of a value proposition and help to expand customer base.

Many customers will be attracted to your machine with above feature, which otherwise has everything already from automatic loading, grinding, UV treatment in single machine.

Question: What is your outlook for 2017-18 and the future of textiles after demonetisation and now under GST regime?

Answer: Demonetisation did not affect the performance of the industry to that extent. But GST is set to bring in a new era with many features. The initial hesitation from certain quarters of the industry, like trading community is due to lack of understanding of the system like filing of returns periodically etc. But in the long run every stake holder is set to gain under the new system.

GST regime will bring both small and big players to an equitable platform. This will also remove the discrimination among the regions due to individual policies prevailing in different states. Now investors can decide more easily on setting up their units, whether near to the raw material producing area or to the consumption point, as the tax implications are going to remain neutral.



Peter Stahlecker
Managing Director

Nannu Spinning Mills –

Social Responsibility and Success: No contradiction



Contact:

Head Office: Daulat Complex (1st Floor), 109,
Islampur Road, Dhaka-1100.

Phone: +88 57393011, +88 57390266

Fax: +88 57390124

Website: www.nannugroup.com



Nannu Spinning Mills Ltd. in Vhulta, Narayanganj, Bangladesh

Nannu Spinning Mills were founded in 2011 and belong to the Nannu Group. They are located on 15 acres of land, about 20 km from Dhaka, Bangladesh's Capital City.

The head quarter is located in the centre of picturesque Old Dhaka. The road is narrow, on both sides of it are shops selling good quality fabrics. It is obvious that Nannu place their emphasis on being the best in textiles, not in having the fanciest head quarters.

In 2012 I had the privilege to meet **Mr. Shoeb** – MD of Nannu Group – for the first time. He struck me as a man with a vision and with the will to make it come true.

In 2012 they had about 24,000 spindles, and had ordered 2 x 1,200 EliTe®. Today, they have 72,048 spindles, of which 69,936 are equipped with SUESSEN EliTe®Compact. This is an annual growth rate of 25 %, something one might expect in "Silicon Valley" – but it has happened right here in Bangladesh and in spinning!

As indicated above, Nannu placed several repeat orders with SUESSEN, after the initial installation of two machines. Naturally, they also tried cheaper competition, but decided that Suessen EliTe® was best for them.

About 50 % of their EliTe®Yarn is used in their own weaving mill. They produce Salwar Kamiz (traditional ladies' wear in Bangladesh and in India) and Lungi (traditional men's wear in Bangladesh, called dothi in India) under their very well-known brand name **BEXI fabrics**. Balance 50 % is sold to weavers, local and export.



Mr. B.M. Shoeb – Managing Director of Nannu Group

In a discussion, Mr. Shoeb told us about his experience using EliTe®Compact for producing weaving yarns, compared to conventional yarn. Yarns spun on EliTe® are Ne 50 to Ne 100.

- Productivity in spinning increased by about 10 %
- Increase in CSP
- Lower hairiness & IPI
- Loom efficiency increased by 5 %
- Better realization
- Lower fly generation both in spinning & weaving
- Higher resistance against abrasion & pilling
- Lower fuzziness on finished fabric
- Extra smoothness of fabric surface

Those who know the demands put particularly on lungi fabrics can appreciate the importance of the last three points listed above.

As the saying goes, *no man is an island*. Like all good and visionary leaders, Mr. Shoeb is supported by a team of dedicated and highly skilled managers, with **Mr. Sirajul Islam** being responsible for spinning.

Mr. Shoeb firmly believes that the only way to eradicate poverty is through growth of the industry, thus providing jobs. His opinion that *standing still is moving backwards* of course is in line with this social responsibility

Making visions into reality. Mr. Shoeb has firm plans to build another spinning mill of 100,000 spindles. Their weaving capacity is to be expanded by 50 % in the near future.

Knowing him, there is no doubt that these visions will soon be reality.

Everybody at Suessen, particularly the two authors of this article (Mr. Ingo Kiefer and myself), are very proud to be associated with Nannu!



EliTe®Compact Spinning at Nannu Spinning Mills



Far Eastern Industrial Wuxi, P.R. China

A branch of the Far Eastern New Century Corporation (FENC) which was founded in 1945 and now is located in Taiwan.



Contact:

Far Eastern Industries Wuxi Ltd
WNDZ 89 Land
Wuxi 214 028
Jiangsu Province
P.R. China

Phone: +86 510 853 42 816

Fax: +86 510 853 41 888

Website: www.feiw.com.cn / www.feg.com

Far Eastern Industries (Wuxi) Ltd., also referred to as "FEIW" was established in 2002 in the city of Wuxi in the Chinese Jiangsu province and around 100 km east of Shanghai.

The entire Far Eastern Group has 262,000 ring spindles, 6,400 Open-End rotor spinboxes and 832 Vortex spindles with a monthly output of around 6,500 tons of yarn.

In the Wuxi branch there are 120,000 ring spindles on various imported machines. Far Eastern always attach much importance to high-class equipment since the demands of their yarn buyers are also high.

The today's GM is Mr. Chen who is also in charge of the spinning sector in Taiwan.

Mr. Mark Wei, from the beginning with FEIW as Deputy Manager and now as Director, is in charge of the whole plant in Wuxi, and he and his team have great influence on everything that is undertaken there.

Some time ago, the question was: Shall we go for compact modification? The easy answer was: Yes! In order to enhance the competitiveness of the Wuxi mill it was necessary to make adjustments.



Front view of the Far Eastern Industrial factory, Wuxi

Two years ago FEIW modified 10 sets of Rieter G33 with Suessen EliTe®CompactSet. According to Mr. Wei the reason for this decision is the wider range of material and yarn counts offered by this system compared to other compacting systems in the market, while the power consumption is the same as for other systems. Yarn quality is always superior to other systems.

Expectations of course were also to sell the compact yarn for a higher price; now the yarn selling price is higher, i.e. 3.5 % more than conventional ring-spun yarn.

Thanks to the input of Mark Wei and his team, Suessen could still improve the first installation step by step. We are looking forward to further cooperation here in the near future as regards repeat orders for modernization with EliTe®Compact.

Comparison of Ring & Compact Yarn (100 % combed cotton)						
Yarn parameters	Ne 40		Ne 32		Ne 20	
	Conv.	EliTe®	Conv.	EliTe®	Conv.	EliTe®
Yarn Count NE	40.3	40.1	31.8	32.3	20.2	20.3
Strength CN	243	257	303	320	472	514
Irregularity CV%	12.4	12.1	11.9	11.6	10.6	9.5
Neps (+140%) ↑/KM	485	270	288	186	31	28
Neps (+200%) ↑/KM	66	53	41	33	7	5
Uster Hairiness H	4.5	3.6	4.3	3.9	5.4	4.6
Zweigle Hairiness 3mm↑/10m	80	55	96	65	140	90
Yarn Twist TPM	964	910	846	810	607	575
Production increase %	5.6		4.3		5.3	

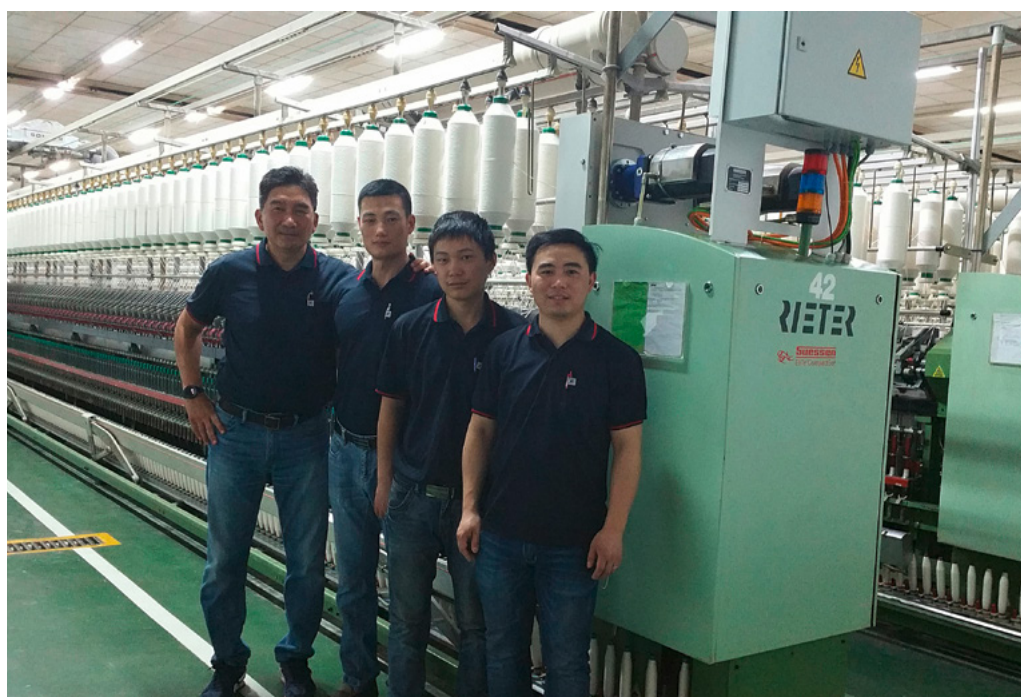

From right to left: Mr. Chen, Gang / Operation Chief, Mr. Ma, Bai Zhong / Maintenance Chief, Mr. Wang, Jiang Tao / Deputy Mill Manager , Mr. Mark Wei / Director

SSM – combined power of over 300 years of experience

SSM Textile Machinery, Horgen (Switzerland), is a subsidiary of the Rieter Group based in Winterthur (Switzerland). It is the one brand and trendsetter that drives the global market in winding technologies and machines. SSM's competencies lie in the handling of the yarn during the winding and yarn processing operations to obtain best packages that combine all the desirable characteristics. This serves as a foundation for the optimization of quality and efficiency in the downstream processes.

In the combined over 300-year-old tradition of the Schärer, Schweiter and Mettler companies, which merged in 1989 to become SSM, the commitment to textile machinery and facilities for yarn processing has always been exceptional. In 1999, two other companies inspired by tradition joined the SSM Group. Stähle-Eltex GmbH and SSM merged to develop air texturing technology and to strengthen their leadership position in the marketplace. And, with HACOBA as partner, SSM is able to offer a complete range of sewing thread finishing machines. In 2012, SSM Schärer Schweiter Mettler AG, Horgen (Switzerland), has taken over the activities of Giudici S.p.A., Galbiate (Italy). Giudici's strong market position in the field of false-twist texturing of high quality fine count nylon yarn, will further expand SSM's business in the chemical fibre processing industry.



Davide Maccabruni (CEO SSM)

On June 30, 2017, Rieter Group acquired the SSM Textile Machinery Division (SSM) from Schweiter Technologies AG, Horgen (Switzerland).

Although people, markets, technologies and fashion are subject to continuous change, at the centre of SSM activities is the endeavour to deliver top products and best solutions for any new demand: that is why SSM customers can rely on a worldwide service network. Thanks to commitment to technological innovation, focused on cooperation with best partners in the field and with industry leaders, nowadays SSM is recognized as innovative leader in yarn processing and winding – Swiss developer, leader and inventor of the electronic yarn traverse system.



Leading  technology for yarn processing and winding

For further information please contact:

SSM Schärer Schweiter Mettler AG

Thomas Elsener
Marketing Service
T +41 44 718 34 17
F +41 44 718 34 52
thomas.elsener@ssm.ch
www.ssm.ch

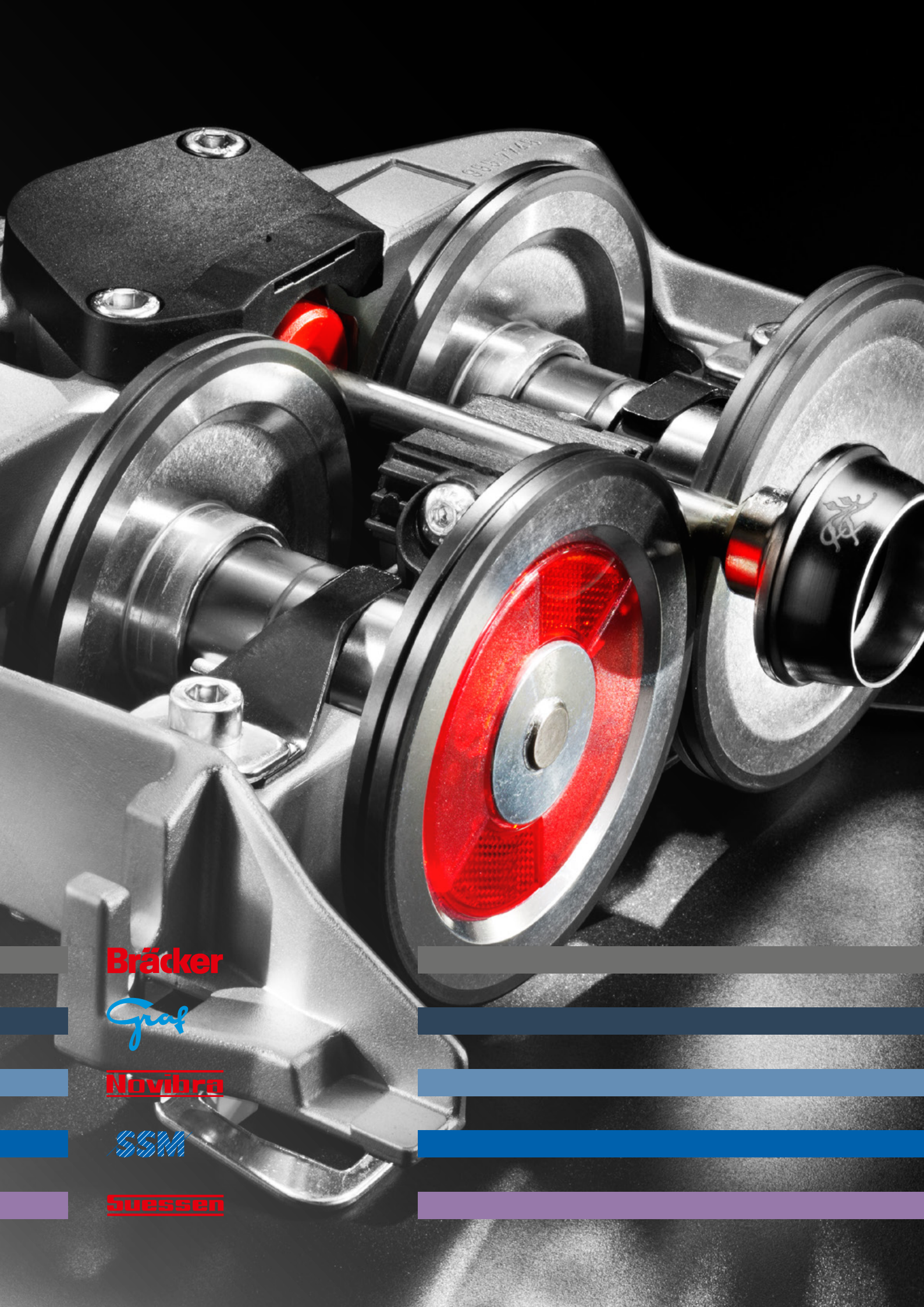

Bräcker

Graf

Novibra

SSN

Suessen