

Compact Spinning
Compact-Spinning Machine K 47

RIETER



K 47

Compact-Spinning Machine K 47



Fully compacted yarns
produced with high efficiency

Shorter Machine Changeover Time

K47



Fast and flexible change of yarn parameter thanks to semi-electronic drafting system. This leads to shorter machine changeover time compared to mechanical systems.

K 47

A close-up photograph of a red industrial machine, likely a lathe or mill, showing several grey spindles with yellow caps. The machine is mounted on a red base. The background is dark and out of focus.

The individual spindle monitoring system ISM basic checks the running properties, ensures a high machine efficiency and can save about 3% of personnel costs.

High Machine Efficiency

700

K47

Up to 80%
Less Energy
for Compacting

A close-up photograph of industrial machinery, likely a paper mill. The image shows several rollers, with two prominent ones in the foreground that are wrapped in bright green material. Below these are several smaller rollers wrapped in white material. The machinery is complex, with various metal components, bolts, and electrical conduits visible. The background is slightly blurred, showing more of the industrial environment.

Thanks to the unique sieve drum compacting system the K 47 reduces the energy consumption up to 80% against other compacting systems.

Wide Range of Raw Materials

New wear-resistant coating on the sieve drum for extended applications

Overall Energy Saving of up to 25%

Unique compacting system and energy-efficient machine concept

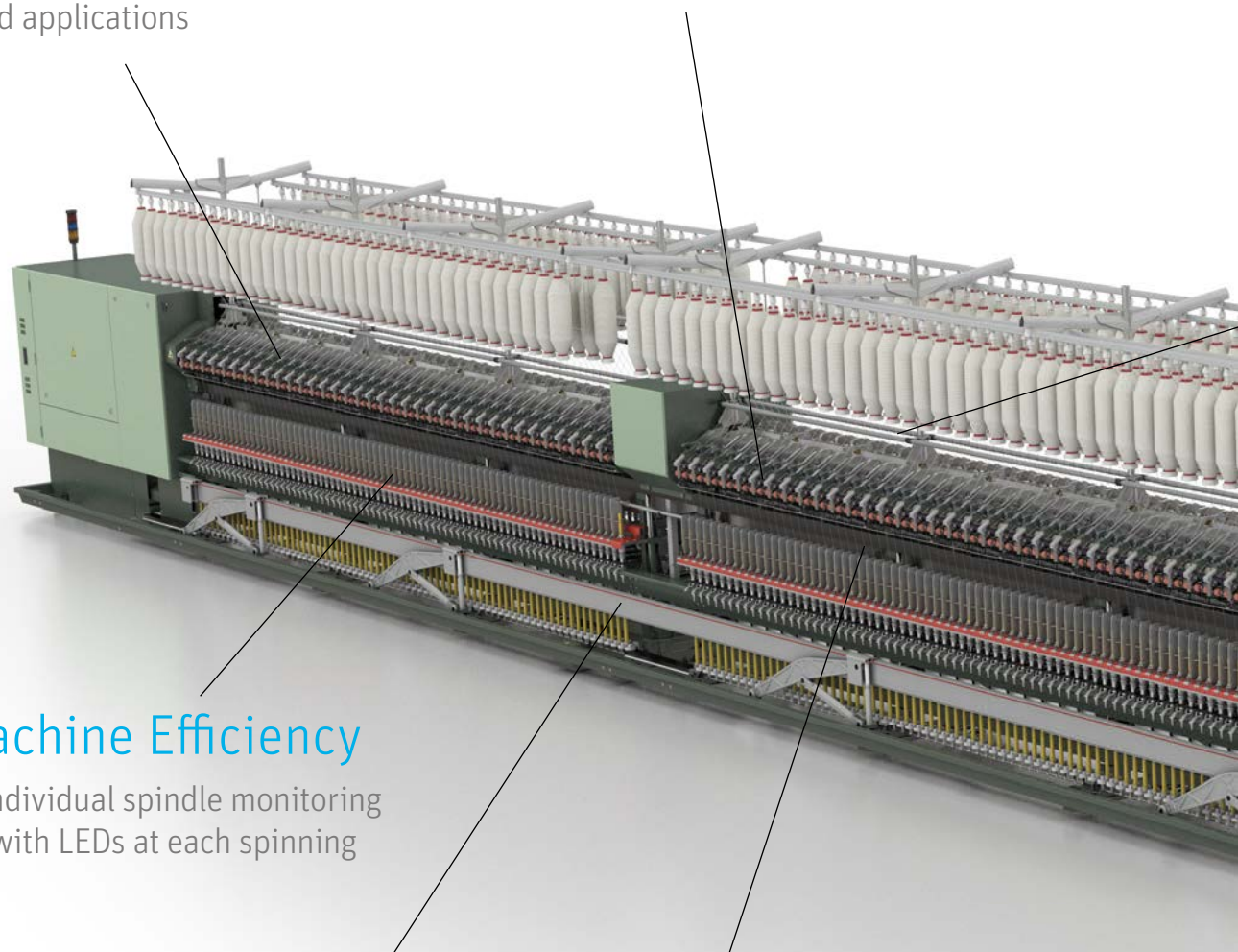

High Machine Efficiency

Integrated individual spindle monitoring (ISM basic) with LEDs at each spinning position

Efficient Doffing

The proven and unique SERVOfrip system makes yarn underwinding for doffing preparation redundant

Highest Level of Productivity at Lowest Maintenance Costs

Unique spinning geometry and optimized machine elements

OUTSTANDING

ADVANTAGES

Full Flexibility for Special Yarns

Equipment for spinning core, slub and twin yarns for all machine length

Minimal Workload

Add-on system WILDload for ROBOload allows tube feed without manual handling

High Yarn Quality

Air guide element Detect ensures precise air guiding and monitors the compacting process

Shorter Machine Changeover Time

The semi-electronic drafting system allows fast change of yarn parameters

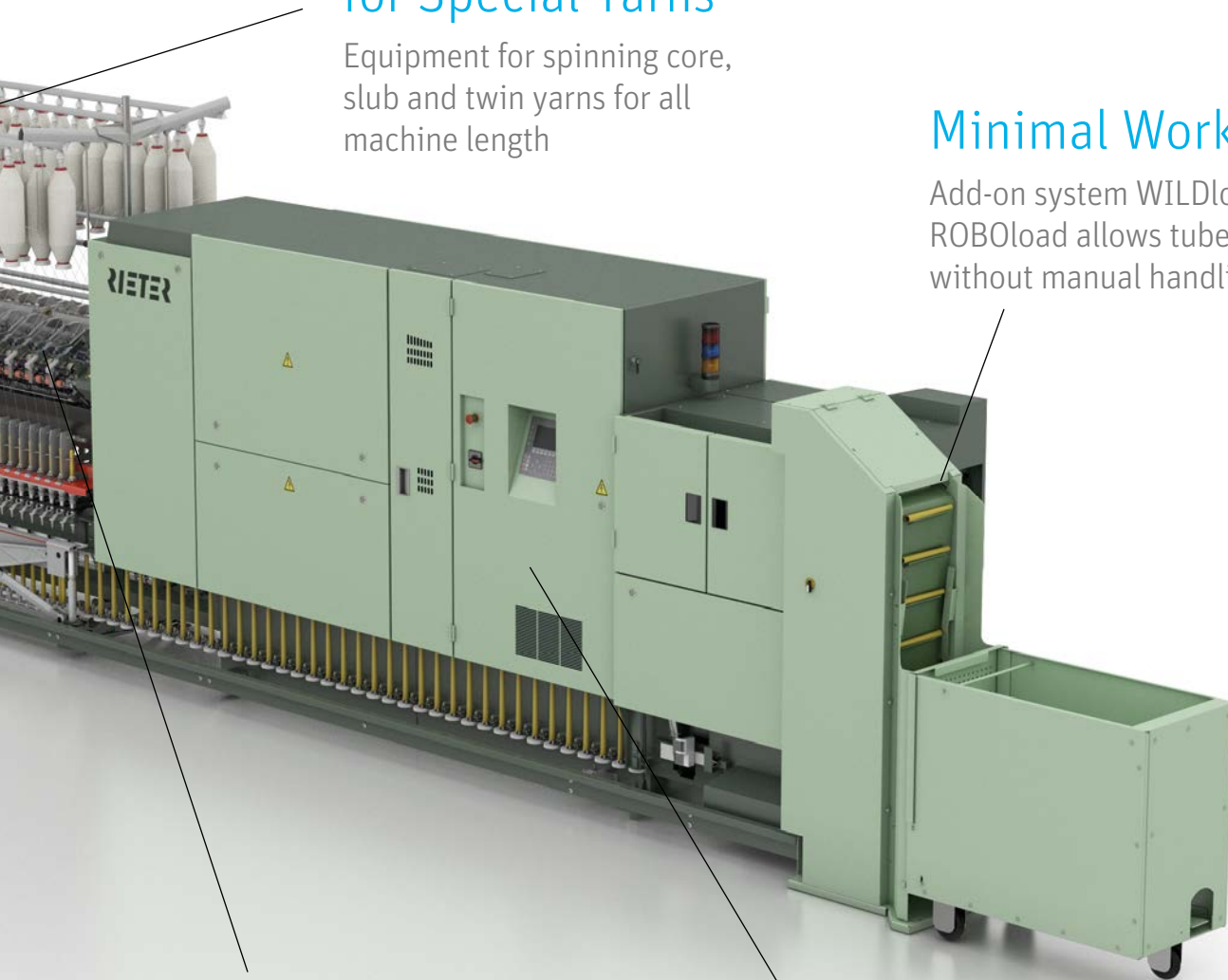

Short Machine Changeover Time

Semi-electronical drafting system

The compact-spinning machine K 47 with the semi-electronic drafting meets all requirements for an economical yarn production. The semi-electronic drafting system allows a fast gear change for yarn count settings.



Machine changeover time for yarn count, yarn twist and Z/S twist changes

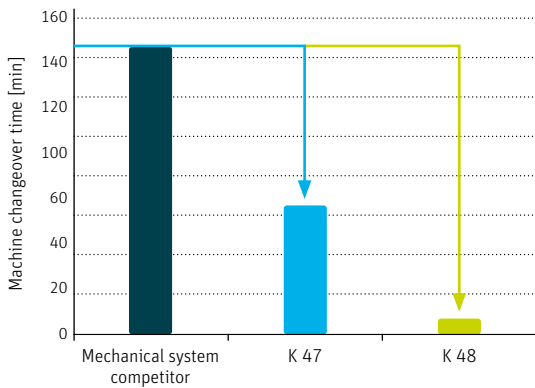

Advantages with semi-electronical (K 47) or fully electronical (K 48) systems

Parameters such as yarn twist and twist direction can easily be adjusted on the machine display. There is no need to change gears or make any other mechanical adjustments. The machine changeover time for a complete yarn parameter change including yarn count, twist and Z or S twist direction is reduced to 65 minutes against 145 minutes with a mechanical system of our competitors.

No ends down in the event of a power failure

If a power failure occurs, the rotational energy of the spindles is used to supply the machine control systems with electricity. At this time, the main motor switches to generator mode. The machine comes to a controlled stop in the event of extended interruptions, thus avoiding ends down.

Full control during a power failure reduces production loss

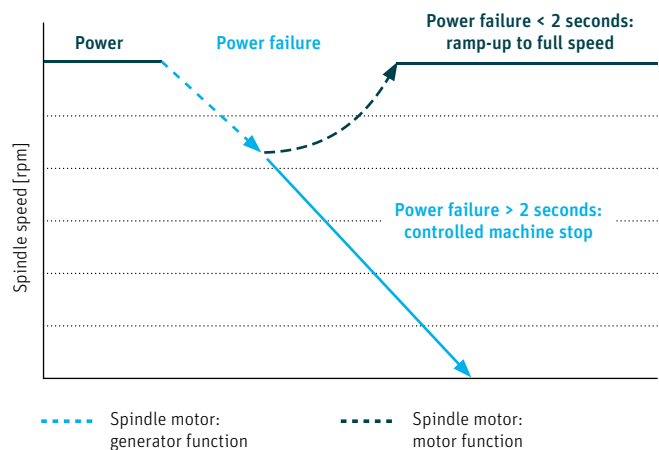

High Machine Efficiency through Digitization

Reliable ends down display with ISM basic

The individual spindle monitoring ISM basic is built into the K 47 as standard. Thanks to LEDs at each spinning position and section, the operator can easily recognize where ends down has occurred. The operator is guided directly to the spindles with ends down. This guidance improves operator productivity and increases the efficiency of the machine.

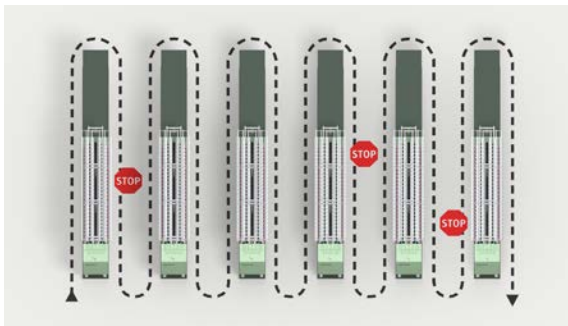

Without individual spindle monitoring – long distances for the operator

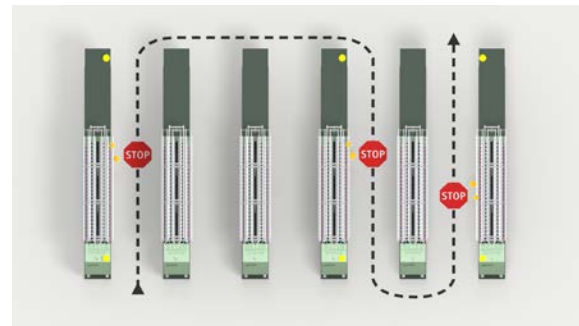

Much less walking distances for the operator with ISM premium

Even more efficient with ISM premium

In addition to LEDs at each spinning position, the optional ISM premium also has an LED at each section and additional signal lamps at the head and foot of the machine. They light up as soon as the individually defined limit for ends down is exceeded. The operator is guided to the relevant side of the machine and then to the affected spindle section with the ends down. Thanks to the three-level display concept, operators are guided to the ends down even more efficiently.

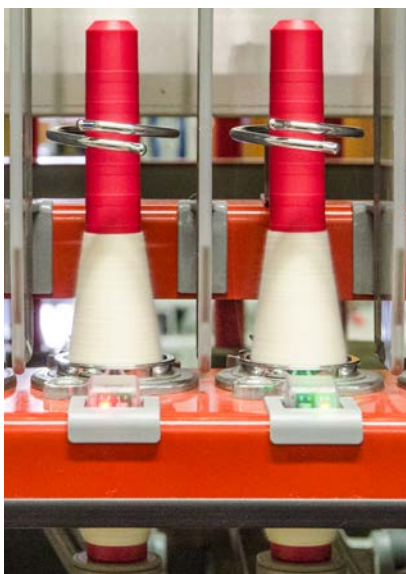

Two different LEDs for spinning position identification

Another function is the permanent monitoring of the speed of the individual spindles. If a spindle runs outside the defined specifications, this is indicated by the LED flashing. This allows the operator to quickly and easily recognize which spindle is not running correctly. The operator can then intervene immediately, which avoids loss of raw material and reduced quality.

As an option, the winding machine can be fitted with spinning position identification. In the event of faulty cops, the winding machine sends a signal to the ISM, and the second LED illuminates at the relevant spinning position. The operator is guided directly to the incorrectly operating spinning position, where they can intervene immediately.

Roving stop is available with ISM premium option. If ends down occurs, the ISM sends a signal to the roving stop, which stops the roving feed. This saves raw material.

ESSENTIAL – Rieter Digital Spinning Suite

ESSENTIAL brings digitization into the spinning mill. The Rieter Digital Spinning Suite analyzes data of the entire spinning mill immediately, which helps the spinning mill’s management to make fast decisions.

ISM collects all necessary data and makes it available for ESSENTIAL. ESSENTIAL then provides meaningful key performance indicators and visualizes improvements for the entire spinning process.

With comprehensive and clearly arranged digital analytics, this mill management system supports the management in order to strengthen the expertise of mill staff, eliminate inefficiencies, and optimize costs.

ESSENTIAL is a modular system. The spinning mill can be gradually digitized. ESSENTIALbasic, the starter package of the Rieter Digital Spinning Suite, is available free of charge for all Rieter customers.

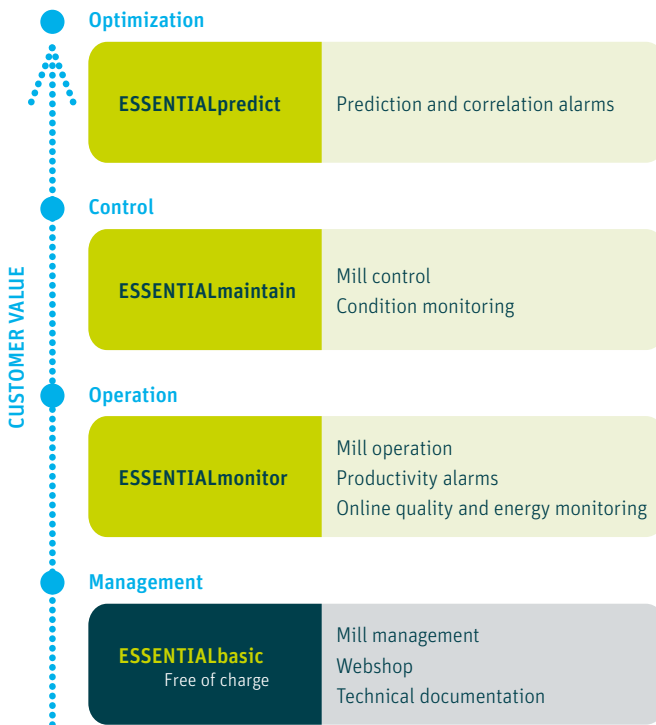

Modular set-up of ESSENTIAL

Economical Doffing Ensures High Efficiency

Save yarn with the SERVOgrip system

The proven and unique Rieter SERVOgrip system enables doffing without underwinding. By using SERVOgrip, no yarn ends occur that need to be removed from the whorl. This saves yarn and keeps the machine clean. Ends down caused by fiber fly and yarn ends are also avoided, thus increasing yarn quality. The SERVOgrip system contains a clamping crown. Rieter is the only manufacturer whose clamping crown is opened and closed using the ring rail. This guarantees precise and controlled fixing of the yarn. Ends down following cops changes are thus largely avoided.

Self-monitoring grippers

The doffing system is self-monitoring, including the special profile of the doffer beam and the releasable grippers. In the event of faults, the doffing process is automatically stopped by a pressure monitor, ensuring highest process safety.

Reliable and economical cops transport with SERVODisc

The cops transport system SERVODisc works using peg trays that are clipped into a conveyor belt, allowing the tubes and cops to be precisely positioned. After doffing, SERVODisc reliably transports the full cops to the cops trolley or the winding machine via the tube loader ROBOLoad.

Reliable yarn cutting for man-made fiber yarns with the SERVOgrip knife

Rieter has developed a patented technology that can reduce yarn twisting and yarn count before doffing. When combined with the optional SERVOgrip knife, even high-strength yarns or core yarns can be cut properly when doffing.



Closed SERVOgrip with knife

Total Machine Energy Saving of up to 25%

Rieter one-duct system for ring and compact-spinning lowers air speed and energy consumption

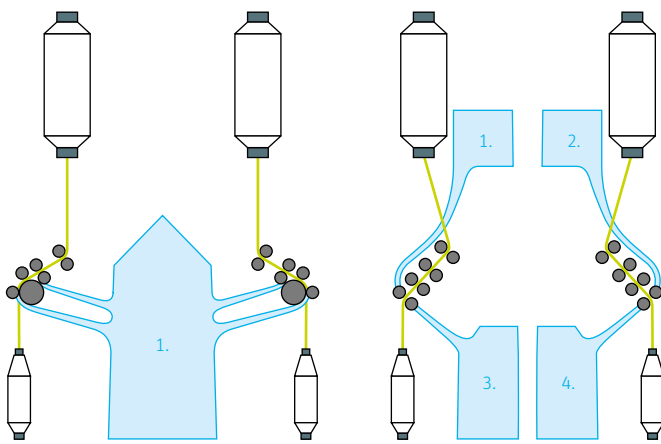

Rieter system with 1 duct

Competitor system with up to 4 ducts

The K 47 requires up to 80% less energy for compacting in comparison to other solutions. This is thanks to a unique compacting system and energy-efficient technology components. The one-duct system for suction reduces the energy consumption needed to generate the necessary underpressure. The large cross-section of the suction duct lowers the air speed and reduces the air resistance.

Less energy required with double-sided suction

The double-sided suction optimizes the aerodynamics of the entire suction system. This reduces the energy that is required to generate the necessary underpressure on machines with up to 1 824 spindles. Compared to single-sided suction system, the same air volume can be transported using less energy. The large duct cross-section and low air speed reduce the air friction. This results in additional energy savings.

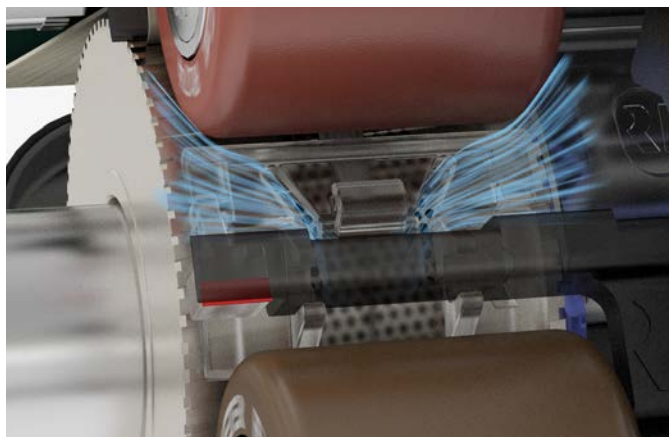
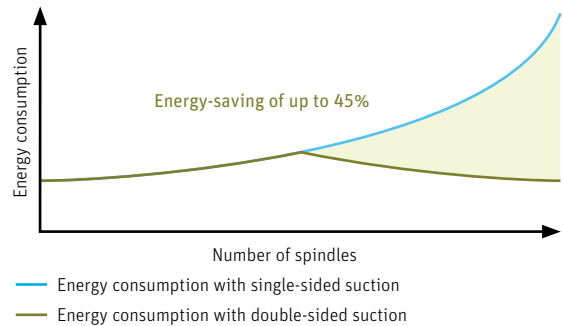

Lower air flow rate thanks to air guide element

The air guide element Detect covers the compacting zone. As a result, the air flow is directed in a targeted manner, significantly reducing the air flow rate required for compacting. Detect also contributes to the reduction in energy consumption.

Energy-saving 4-spindle tape drive

The Rieter 4-spindle tape drive is energy-efficient and easy to handle. The large enlacement of 90 degrees ensures that every spindle operates without failure, even with minimal contact pressure. The low contact pressure guarantees low energy consumption.

Save up to 4% energy with the LENA spindle

The LENA spindle has been specially developed for high spindle speeds and low energy consumption. A whorl diameter of 17.5 mm and other optimizations make a significant impact on energy efficiency.

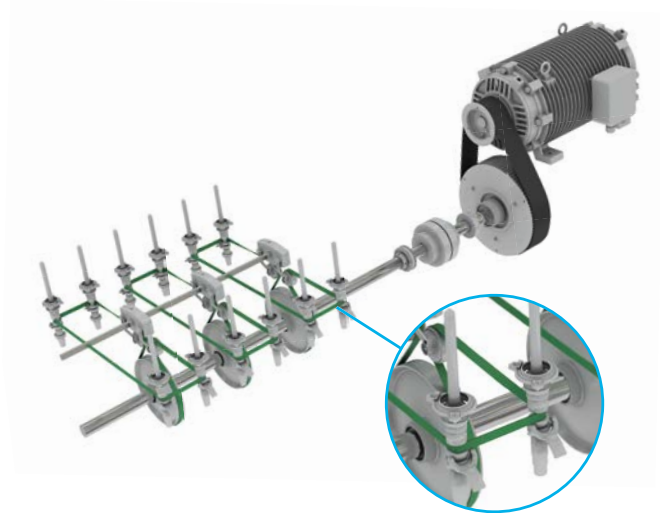

Optimal power transmission due to the 90° enlacement, reducing energy consumption

Efficiency depends on technology and motor size

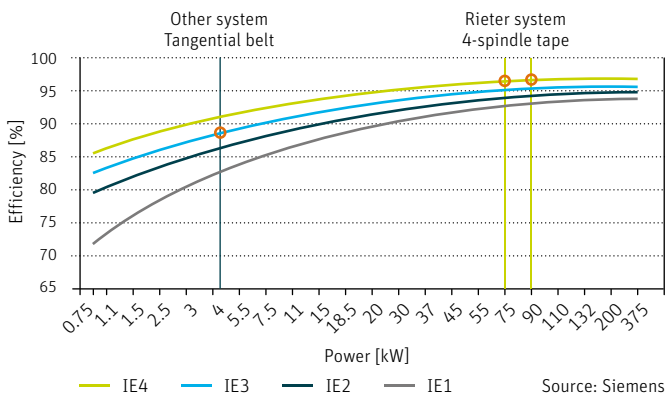

Efficient IE4 main motor drive

The extremely efficient IE4 main motor drives were developed for high speeds to save energy. It can also be used profitably on machines with fewer spindles and low speeds due to its permanent magnetic functioning.

Efficiency is not only related to motor technology but also to motor size. With one single spindle motor and the choice of IE4 motors, Rieter invests in sustainable yarn production.

All these energy saving measures of the compact spinning machine K 47 keep the energy consumption low and lead to total machine energy savings of up to 25%.

Break Down of Total Energy Consumption

The final spinning machine accounts for a large part of the energy consumption in ring and compact yarn production. For this reason, Rieter is here particularly investing in energy-efficient technologies and developments.

More than 80% of the energy is consumed for the spindle drive and here the proven 4-spindle belt drive with only one large drive motor shows advantages. Lower torques in the drafting system with the sieve drum result in significantly lower energy consumption. Field tests have shown a saving of 36% compared to an apron system. The optimized suction system saved 31% energy compared to another system, also determined in the same field test.

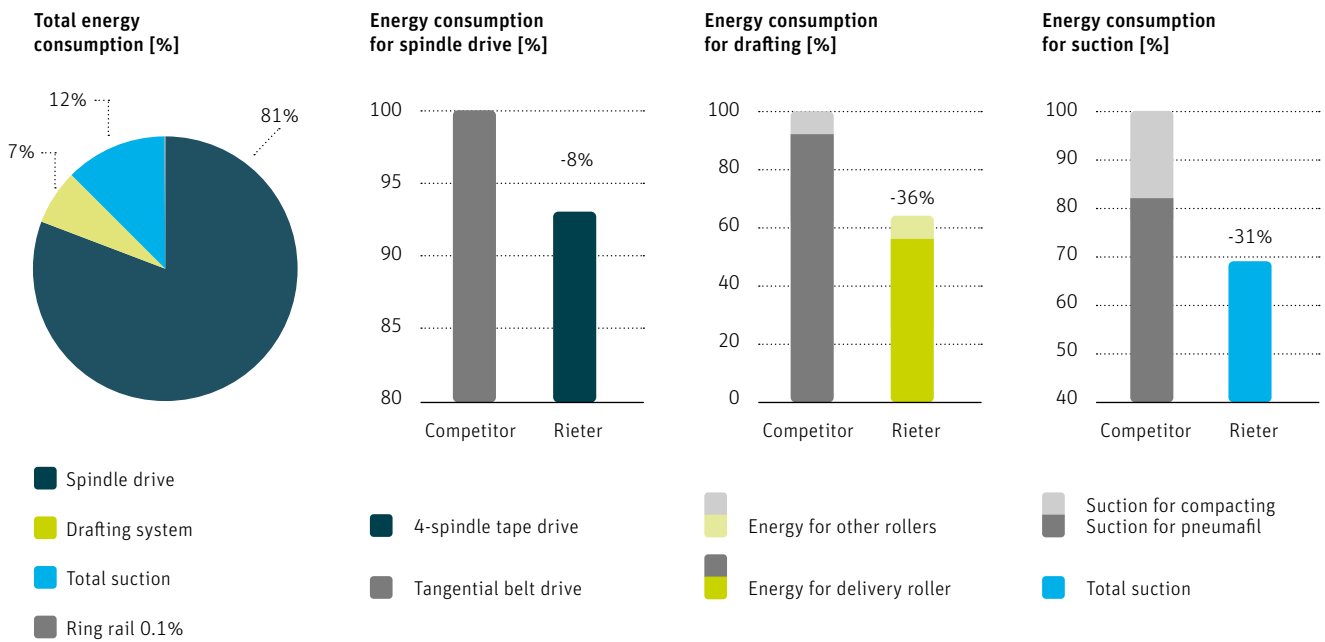

Rieter vs. competitor tangential belt and apron system: Ne 30, 19 500 rpm, 775 T/m, 1 824 spindles

Minimal Workload



[Link to the winding machine](#)



ROBOload



ROBOload with add-on system WILDload

Flexible automation

Various automation options are available. With the SERVODisc system, the compact-spinning machine can either be directly linked with a winding machine or with the tube loader ROBOload.

Tube loader ROBOload with trolley and add-on system WILDload

The system WILDload means significantly less work for operating personnel. The tubes are loaded into a trolley at the winding machine which is then clicked directly onto the ROBOload. No manual work is required.



System WILDload: The tubes are picked up one at a time and are then aligned before being fed into the tube loader ROBOload.

Maximum Yarn Quality with High Productivity

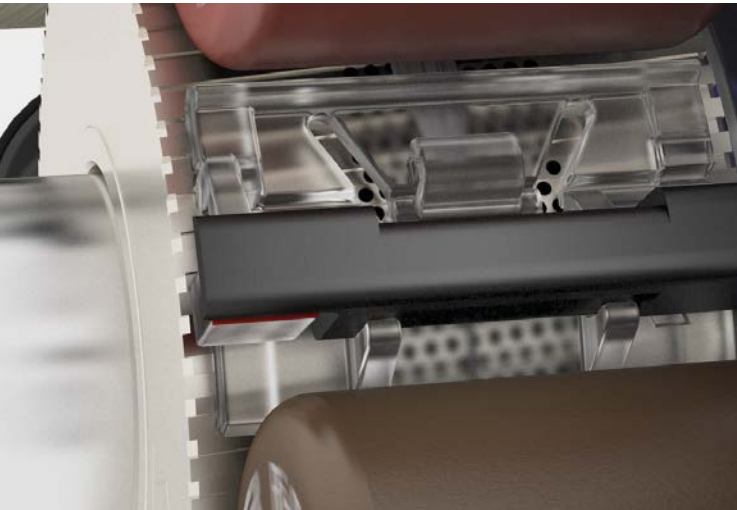

Targeted air routing via the air guide element Detect

High yarn quality with permanent monitoring

The compacting unit forms the heart of the compact-spinning machine. The compacting unit comprises the sieve drum, suction insert Bright, and air guide element Detect. The optimal shape of the air guide element and suction insert ensures that the drawn-in air is guided in a targeted manner. The fibers to be spun are neatly and continuously incorporated into the yarn body via the air flow drawn in at the sides. The targeted air routing in the compacting unit prevents dust and fiber particles from being deposited inside the machine. By doing so, the machine is always able to produce fully compacted yarn with the highest strength and low hairiness.

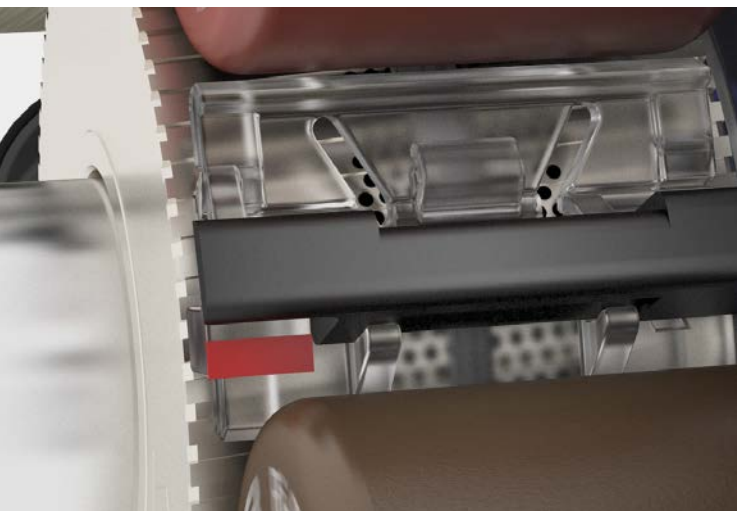

The red marking on the air guide element Detect indicates that the compacting unit must be checked

Unique and simple quality monitoring

The air guide element Detect monitors the air flow at the individual spinning positions. If the underpressure reaches a lower limit value, a red marking on the air guide element indicates that the compacting unit must be checked. This feature prevents non-compacted yarn being produced. Monitoring each individual spinning position secures a consistently high yarn quality.

Proven intermediate drive ensures quality

For machines with an intermediate drive unit, the middle bottom roller is driven in the center of the machine. This reduces the torsional forces on the bottom roller. The even running of the bottom roller ensures a consistent quality of the yarn.

Q-Package – the quality package for cotton

The quality package Q-Package for cotton contains a stepped nose bar, an “active” cradle and a corresponding pressure bar (pin). Fiber guidance between the cradle and the nip point of the delivery roller is further improved with the Q-Package. The evenness of the yarn (CVm%) is improved by up to one percentage point. At the same time, yarn imperfections are reduced by 10 to 30%.

Ideal fiber guidance in the drafting system

The Ri-Q-Draft drafting system ensures the ideal fiber guidance for most applications and very stable running behavior. The nose bar Ri-Q-Bridge is a key component in the spinning process. The optimal position and form of the cradle reduce the distance to the nipping point of the delivery roller. All the listed technology components, including the bottom aprons, are perfectly tailored to each other. This ensures ideal fiber guidance in the main draft zone.



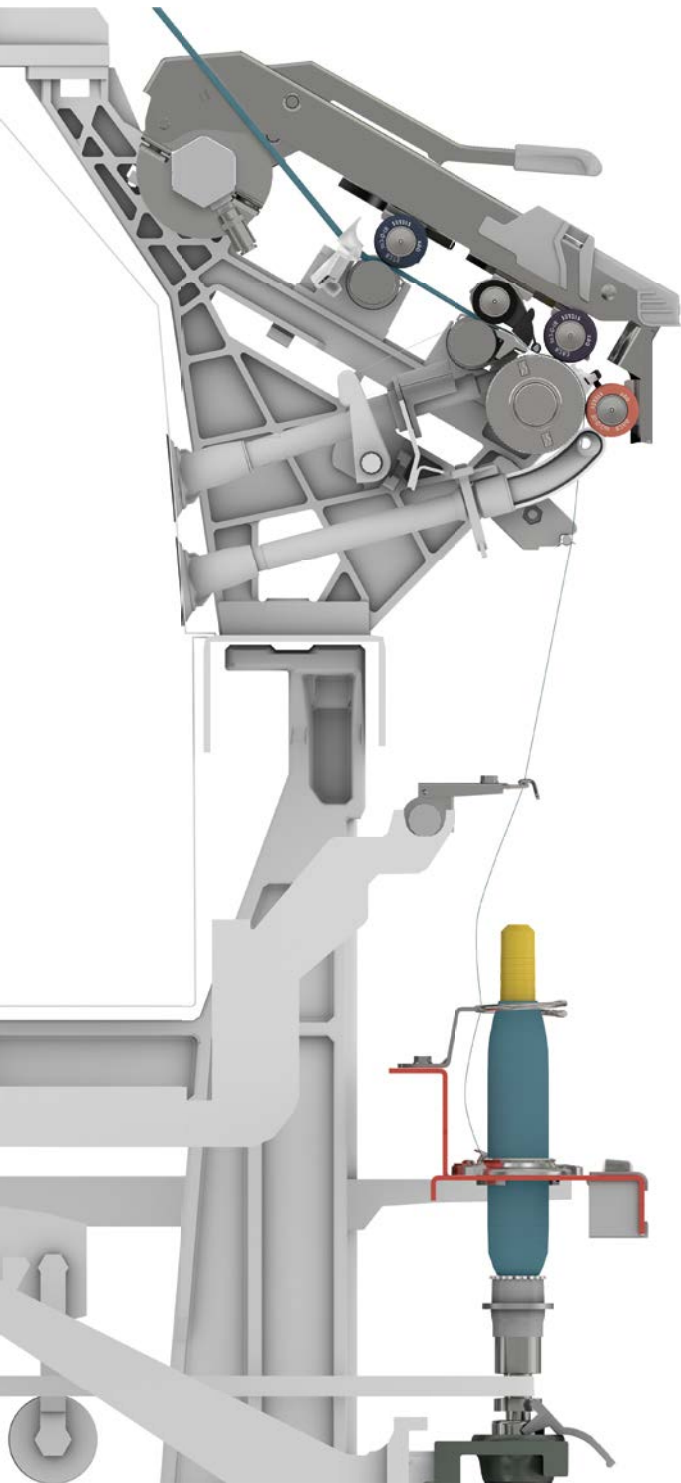

Maximum spindle speeds

With its unique Rieter spinning geometry and the consistent use of high-quality technology components, the K 47 runs at the highest spindle speeds. These high speeds ensure maximum production with a consistently high yarn quality. For example, with a yarn count of Ne 30, up to 10% more yarn can be produced per machine each year.

Productivity is more than maximum spindle speed

Production can be increased even when the cops is in the build-up stage. The precise machine design of the K 47 and the use of high-quality components allow the machine to run at higher starting speeds. Such speeds can increase production rates, especially in the lower end of the cops size range. The maximum spindle speed is reached quicker. At a yarn count of Ne 30, for example, it is therefore possible to produce an additional up to 6 500 kilograms of yarn on each machine each year.

Up to 2% higher productivity using the same maximal spindle speed

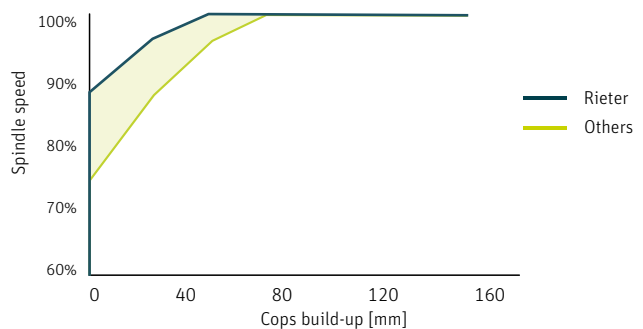

Low spinning costs

With the K 47 the labor-intensive and expensive exchange of compacting aprons is not needed. Machine downtimes are avoided. Increased efficiency can be achieved as a result, making it simpler to plan production.

Wide Range of Raw Materials

Basis for a wide range of applications

The sieve drum requires minimal maintenance and is therefore a basis for consistent yarn quality over a prolonged period. The surface of the sieve drum ensures a good and above all uniform yarn quality over long operating periods.

A highly abrasion-resistant sieve drum is available as option. This new coating increases the application range even more. Different raw materials, blends and yarn counts can be spun with the shortest time for a machine changeover.

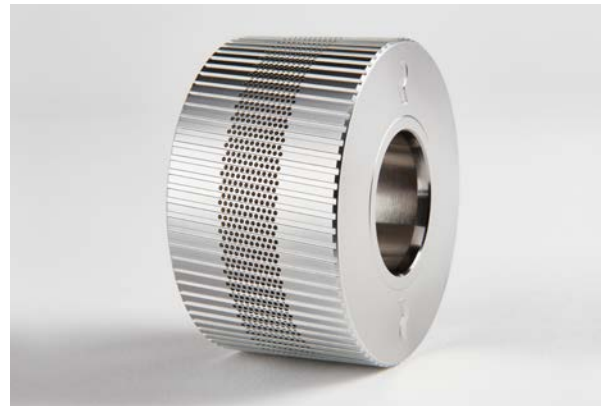

Sieve drum available with highly abrasion-resistant coating



Full Flexibility for the Production of Standard and Special Yarns

Produces slub yarns at any time

The compact-spinning machine K 47 is an all-rounder that allows the business to respond quickly to changing market requirements. Optionally, the machine can be equipped with a slub yarn or multi-count system. The latest generation servo motors are ideal for the high dynamics involved in slub yarn production.

A range of slub designs can easily be programmed on the operating unit or an external computer with the appropriate software. This allows slub yarns to be produced efficiently and profitably with outstanding Rieter quality.

Precise production of core yarns

With the different core yarn devices, soft, hard, and dual core yarns can be produced. The filament is always precisely integrated into the yarn. The core yarn devices work with a traversing guide roll for the filament. The traversing system for the filament is aligned with the traversing system of the roving.

Easy production of twin yarns

To produce a twin yarn, two rovings must run to one spinning position. In the drafting system, both are drafted separately. The rovings are then twisted together in the spinning triangle. Due to their 2-ply-like characteristics, twin yarns improve the quality of the yarn and the end product.



Advantages for Downstream Processing

Better efficiency of the weaving machine

High strength and low hairiness are important factors for good running behavior on the weaving machine. These characteristics are provided by the Com4®compact yarns produced on the K 47. The high strength improves the load capacity of the warp threads and the low hairiness reduces the clinging tendency during shed formation. This results in high efficiency levels and low costs thanks to reduced machine downtimes.

Reduced clinging tendency with Com4®compact yarns

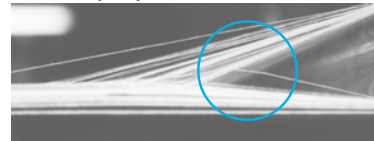

Ring yarn

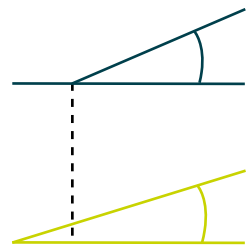
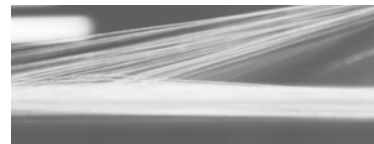

Clear, open weaving shed

Reduced needle wear on the knitting machine

Needle wear on the knitting machine

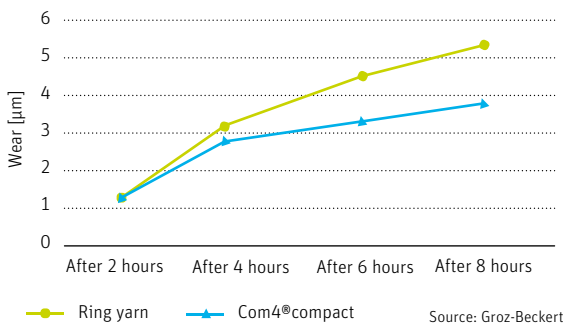

In the knitting mill, having yarn that is not as hairy supports the smooth running of the knitting machine. Less fiber fly is generated and the smoother yarn reduces wear on the needles. Fewer machine standstills lead to a better utilization capacity of the knitting machine.

High flexibility in finishing

The finishing of woven and knitted fabrics places high demands on the yarns used. The popular non-iron finishing of shirts and blouses, for instance, reduces the strength of the yarns used by up to 50%. The high strength of the Com4®compact yarn provides the necessary reliability and flexibility for customer-friendly and high-quality fabric finishing.



Machine Data

Compact-spinning machine K 47

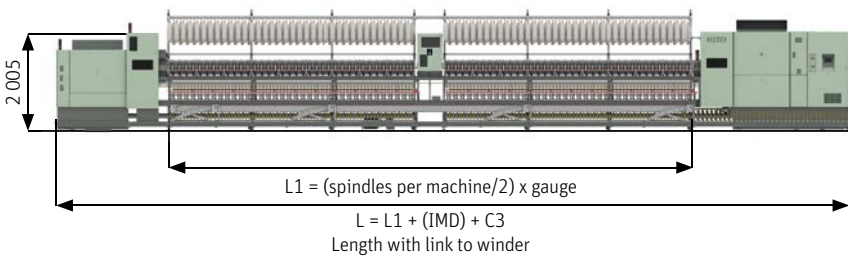
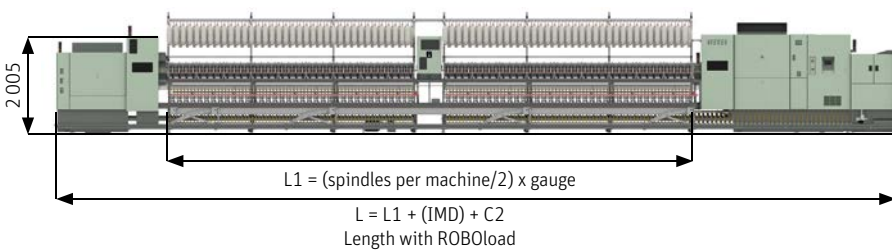
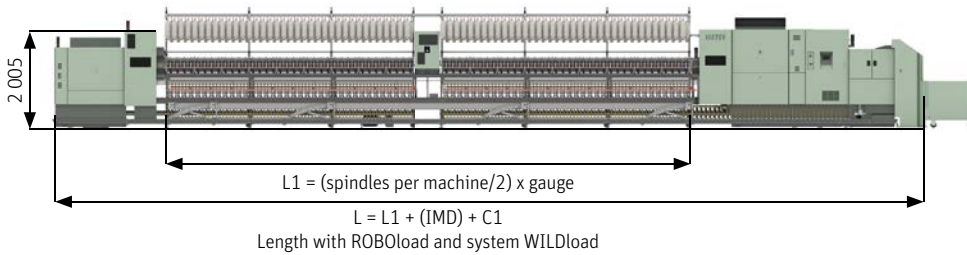

Machine length L [mm]

$L = (\text{no. spindles}/2 \times \text{gauge}) + \text{intermediate drive} + \text{Constant (C)}$

Maximum number of spindles

Up to 1 824 spindles per machine

Machine without an intermediate drive

Up to 1 248 spindles: all raw materials

Up to 1 440 spindles: 100% cotton

Length of intermediate drive (IMD): 600 mm

Length of ROBOload: 1 005 mm

Length of add-on system WILDload: 643 mm

Length of trolley: 980 mm and 1 200 mm available

Total head- and endstock length depending on version [mm]

Suction	Single-sided*	Double-sided*
C1: ROBOload and system WILDload without trolley	5 828	7 284
C2: ROBOload without trolley	5 185	6 641
C3: Link to Murata, Savio, Schlafhorst	4 180	5 636

*Single-sided suction is available for up to 1 632 spindles. Double-sided suction always has an intermediate drive and is available from 1 296 spindles.

Sample calculation for machine length L [mm]

1 824 spindles, 70 mm gauge, intermediate drive, double-sided suction, link
 $L = ([1\ 824/2] \times 70) + 600 + 5\ 636 = 70\ 076 \text{ mm}$

Technological data	
Material	Cotton \geq 27 mm (1 1/16 in); Man-made fibers and blends up to 51 mm (2 in)
Yarn count	
Standard	29.5 – 3.7 tex Nm 34 – 270 Ne 20 – 160
Twist range	400 – 3 000 T/m (10.2 – 76.1 T/in)
Draft	12 – 80-fold
Fancy yarn draft drive (optional)	8 – 250-fold

Machine data	
Spindle gauge	70
Ring diameter	
70 mm gauge	36; 38; 40; 42 mm
Number of spindles (gauge 70 mm)	
Max.	1 824
Min.	288 (144 on request)
Per section	48
Tube length	
70 mm gauge	180 – 210 mm
Machine width	
Over center of spindle	660 mm
Doffer retracted	1 062 mm
Doffer extended	1 380 mm

Technical data	
Spindle speed	Mechanical up to 25 000 rpm
Installed power	
Main drive motor depending on spindle number	55; 80 kW (IE3) 75; 90 kW (IE4)
Drafting system drive	
(for 100% cotton)	
up to 576 spindles	1 x 6.5 kW
624 – 864 spindles	2 x 4.0 kW
912 – 1 440 spindles	2 x 6.5 kW
1 448 – 1 824 spindles	2 x 6.5 and 1 x 4.0 kW (IMD)
Ring rail drive	1.75 kW
Single-sided suction on the power supply (50/60 Hz)	
up to 960 spindles	6.5 kW
1 008 – 1 200 spindles	9.0 kW
1 248 – 1 440 spindles	12.6 kW
1 488 – 1 632 spindles	12.6 kW with larger impeller
Single-sided suction with converter (50/60 Hz)	
up to 960 spindles	6.5 kW
1 008 – 1 440 spindles	12.6 kW
Double-sided suction with converter (50/60 Hz)	
1 296 – 1 824 spindles	2 x 6.5 kW
Mains connection	
Rated voltage	380 – 440 V; 50/60 Hz Other rated voltages available on request
Compressed air	
Min. supply pressure	7 bar
Consumption	approx. 1.5 Nm ³ /h (up to 1 440 spindles) approx. 1.75 Nm ³ /h (up to 1 632 spindles) approx. 2 Nm ³ /h (up to 1 824 spindles)
Exhaust air	
Air volume during double-sided suction (even split of air volume in the head and foot of the machine)	12 420 m ³ /h with 1 632 spindles 13 824 m ³ /h with 1 824 spindles
Required underpressure at transition point	50 – 200 Pa

Options

- ISM premium
- Q-Package
- SERVOflex grip knife
- Slub and multi-count device
- Core yarn device
- Twin yarn
- LENA spindle
- Power monitoring
- DOFFlock
- ROBOload with system WILDload
- ESSENTIAL
- Roving stop device



Com4[®]compact

Yarn of Choice

Com4[®]compact

The unique character of the Com4[®]compact yarn spun on the Rieter compact-spinning machine lies in the almost perfect yarn structure. All fibers lie parallel and are completely integrated in the yarn bundle. Compared to standard compact yarns, it exhibits the highest compacting efficiency. This leads to excellent strength properties. The very low hairiness and the compact structure give both the yarn and the fabrics a high-quality, distinctive appearance. First-rate processing characteristics, high wearing comfort and a luxurious look are the advantages.

Yarn Characteristics

- Highest strength
- Uniform yarn structure
- Low hairiness
- High yarn density

Advantages for Downstream Processing

- High processing speed
- Low ends down during weaving
- High strength after finishing

Fabric Properties

- High fabric tenacity
- Absolutely clear, defined contours
- Finest luster

Typical Applications

- Business shirts
- High-quality knitwear
- Fine bed linen
- Fine hosiery

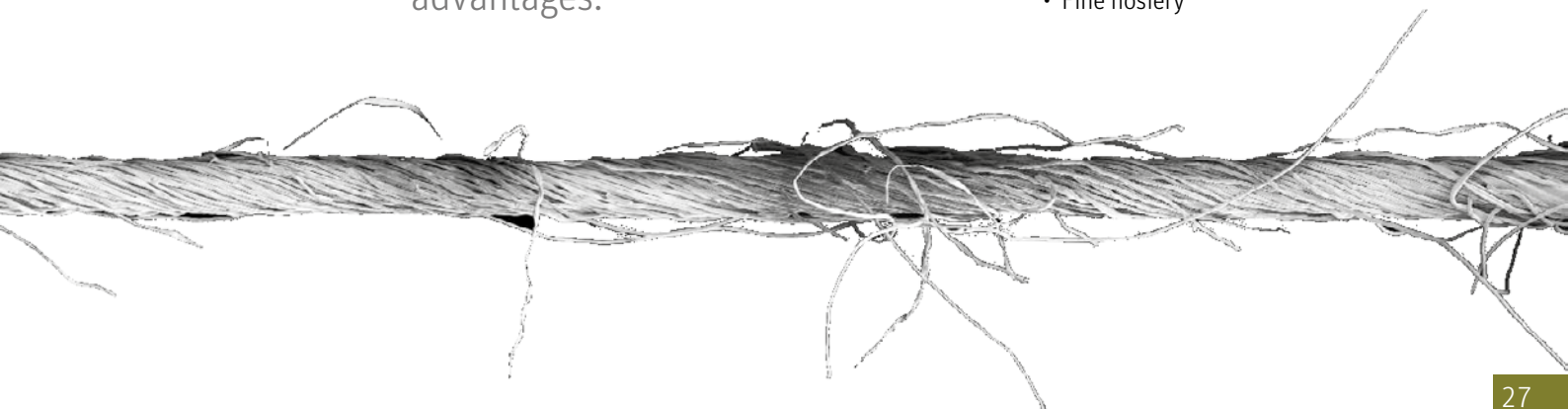

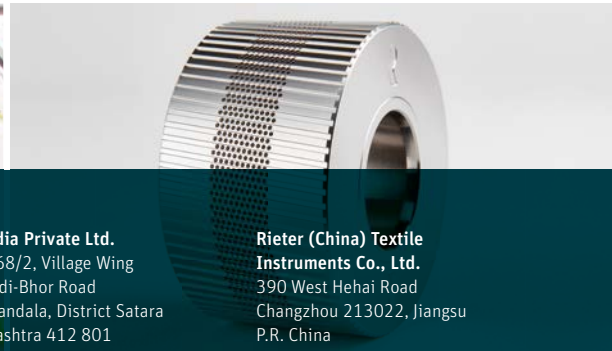

Rieter Machine Works Ltd.

Klosterstrasse 20
CH-8406 Winterthur
T +41 52 208 7171
F +41 52 208 8320
machines@rieter.com
aftersales@rieter.com

Rieter India Private Ltd.

Gat No. 768/2, Village Wing
Shindewadi-Bhor Road
Taluka Khandala, District Satara
IN-Maharashtra 412 801
T +91 2169 664 141
F +91 2169 664 226

**Rieter (China) Textile
Instruments Co., Ltd.**

390 West Hehai Road
Changzhou 213022, Jiangsu
P.R. China
T +86 519 8511 0675
F +86 519 8511 0673

www.rieter.com



The data and illustrations in this brochure and on the corresponding data storage device refer to the date of printing. Rieter reserves the right to make any necessary changes at any time and without special notice. Rieter systems and Rieter innovations are patent protected.

3226-v3 en 2009